



Commercial Roofing **Products**

Excellence in Roofing, Service Beyond Compare...



There is no equal to **PLATINUM!**



PLATINUM

ROOFING PRODUCTS INC.

At Platinum Roofing Products, we pride ourselves on being a premier manufacturer of industrial roof drains and related accessories. Our expertise lies in designing and producing high-quality products that meet the rigorous demands of various industries. By controlling every step of the manufacturing process, we ensure that our roof drains and accessories are crafted to the highest standards of durability and performance.



www.platinumroofingproducts.com

Please note that PLATINUM products may be periodically updated & are subject to change without prior notice.

For additional information, contact **PLATINUM ROOFING PRODUCTS**

1-800-538-7767

info@platinumroofingproducts.com

PLATINUM Warranty

Platinum Roofing Products Inc. ("Company") is pleased to offer a twenty (20) year limited warranty to any purchaser ("Purchaser") of its products ("Product"), and in the case of Stainless-Steel Product, a lifetime limited warranty. This limited warranty shall only apply when the Product is installed in the continental United States by an installer approved by the Company or otherwise in accordance with industry standards ("Standards").

WHAT IS COVERED BY THIS LIMITED WARRANTY?

If the Product is proved to have failed as a result of a manufacturing defect during the twenty (20) year warranty period, or lifetime for Stainless-Steel Product, despite installation in accordance with the Standards, then the remedies set forth below shall apply. Claims for any breach of warranty must be made within the period of this limited warranty. Claims must be reported in writing to Company within thirty (30) days of discovery, and Company shall be given a reasonable opportunity to inspect Product claimed to be defective. Customer must prove that the defective Product was sold by Company by supplying a proof of purchase. Customer must pay for all labor and shipping costs associated with removing, returning and/or reinstalling the Product.

WHAT IS NOT COVERED BY THIS LIMITED WARRANTY?

This warranty covers only defects in the Product and does not cover the following:

1. Damage resulting from anything other than an inherent manufacturing defect in the Product;
2. Damage resulting from causes beyond normal wear and tear, such as unusual weather conditions, natural disasters or any act of God;
3. Damage resulting from improper storage, handling, installation or application of the Product;
4. Damage resulting from faulty building construction; or
5. Damage caused by inadequate roof maintenance or Product maintenance.

WHAT IS THE REMEDY UNDER THIS LIMITED WARRANTY?

The exclusive remedy and Company's sole liability for breach of this limited warranty shall be, at Company's sole option, to either (1) replace the Product FOB its nearest distribution point, or (2) refund Customer for the original cost of the Product. No claims will be allowed for labor, shipping or other incidental costs.

DISCLAIMER OF WARRANTY

Company gives no other warranties for the Product except those expressly contained in this limited warranty. COMPANY DISCLAIMS ALL OTHER WARRANTIES, EITHER EXPRESS OR IMPLIED, INCLUDING BUT NOT LIMITED TO THE IMPLIED WARRANTIES OF MERCHANTABILITY AND FITNESS FOR A PARTICULAR PURPOSE, WARRANTIES ARISING FROM COURSE OF DEALING OR USAGE OF TRADE AND WARRANTIES OF NONINFRINGEMENT.

LIMITATION OF LIABILITY

COMPANY'S SOLE AND COMPLETE RESPONSIBILITY FOR PROVED DEFECTIVE PRODUCT IS AS SET FORTH IN THIS LIMITED WARRANTY. IN NO EVENT SHALL THE LIABILITY OF COMPANY EXTEND TO PERSONAL INJURY, PROPERTY DAMAGE, LOSS OF PROFIT, DELAY OR ANY INCIDENTAL OR CONSEQUENTIAL DAMAGES RESULTING FROM THE FAILURE OF PRODUCT TO CONFORM TO THE PROVISIONS OF THIS LIMITED WARRANTY. COMPANY SHALL NOT IN ANY EVENT BE LIABLE FOR THE COST OF LABOR EXPENDED BY OTHERS ON ANY DEFECTIVE PRODUCT OR FOR ANY SPECIAL, INDIRECT OR CONSEQUENTIAL DAMAGES WHATSOEVER WHETHER ARISING FROM BREACH OF CONTRACT, BREACH OF WARRANTY, TORT, INCLUDING NEGLIGENCE, STRICT LIABILITY, OR ANY OTHER THEORY OF LIABILITY, ARISING OUT OF OR IN CONNECTION WITH THE USE OF OR INABILITY TO USE THE PRODUCT EVEN IF COMPANY HAS BEEN ADVISED OF THE POSSIBILITY OF SUCH DAMAGES.

WARRANTY MODIFICATIONS

This limited warranty shall not be changed or modified except in writing, signed by an officer of Company. No one (other than an officer of Company) has the authority to assume any additional or other liability or responsibility for Company in connection with the Product except as described in this limited warranty. The limited warranty in effect at the time the Product was installed is the version of the warranty that will govern the claim.

OTHER TERMS

The substantive law of the State of Delaware shall exclusively govern the rights and duties of the parties under this limited warranty. All claims and disputes arising under or relating to this limited warranty are to be settled by binding arbitration in New Castle County, Delaware.

This limited warranty is effective for any Product installed after December 1, 2023.

Questions concerning this limited warranty should be directed to Company



01	Premium Roof Drains	
	I. Stainless Steel Roof Drains _____	01
	II. Aluminum Roof Drains _____	03
	III. Copper Roof Drains _____	07
02	Economy & Temporary Roof Drains	
	I. Aluminum Roof Drains _____	11
	II. Copper Roof Drains _____	12
03	Roof Drain Accessories	
	I. Drain Seals _____	13
	II. Drain Domes _____	14
	III. Clamping Rings (Flanges) _____	15
	IV. Flow Control Restrictors _____	16
04	Roof Drain Add-Ons	
	I. Stainless Steel Ballast Guard _____	17
	II. Under-Deck Clamps _____	17
05	Rain Collars	
	I. Galvanized Metal Rain Collars _____	18
06	Flashings	
	I. Electrical Flashings _____	19
	II. Roof Anchor Flashings _____	21
	III. EPDM Rubber Boots _____	22
07	Tall Cones	
	I. Spun Aluminum Tall Cones _____	23
08	Vent Stacks	
	I. Vent Stacks _____	24
	II. Wide-Base Vent Stack _____	24
	III. Oversize Vent Stacks _____	25
	IV. Insulated Vent Stack _____	26
	V. Vent Stack Caps _____	27
09	Breathers	
	I. Insulated One-Way Breather _____	29
	II. Two-Way Breather _____	30
10	Smart Roof System	
	I. SmartBlox Kit with 3 1/2" Clamp _____	31
	II. SmartBlox 2 1/2" Pipe Clamp Add-On _____	32
	III. SmartBlox 6 1/2" Pipe Clamp Add-On _____	32
	IV. SmartBlox 4" Mid-Section Add-On _____	32
	V. SmartBase _____	33
	VI. SmartBase Leveling Shims _____	33
11	Accessories	
	I. Drain Dome Marker _____	34
	II. Gas Line Marker _____	34
	III. Seal Screwdriver _____	35
	IV. Termination Bar _____	35
	V. Skid Bags on Roll _____	36
	VI. Plastic Bags on Roll _____	36
	VII. Blu.Grit Cleaner _____	37
	VIII. Tar & Asphalt Remover _____	37
	IX. FIREGUARD Retardant Coating Spray _____	38
	X. QUICKSTOP Polymer Absorbant _____	38

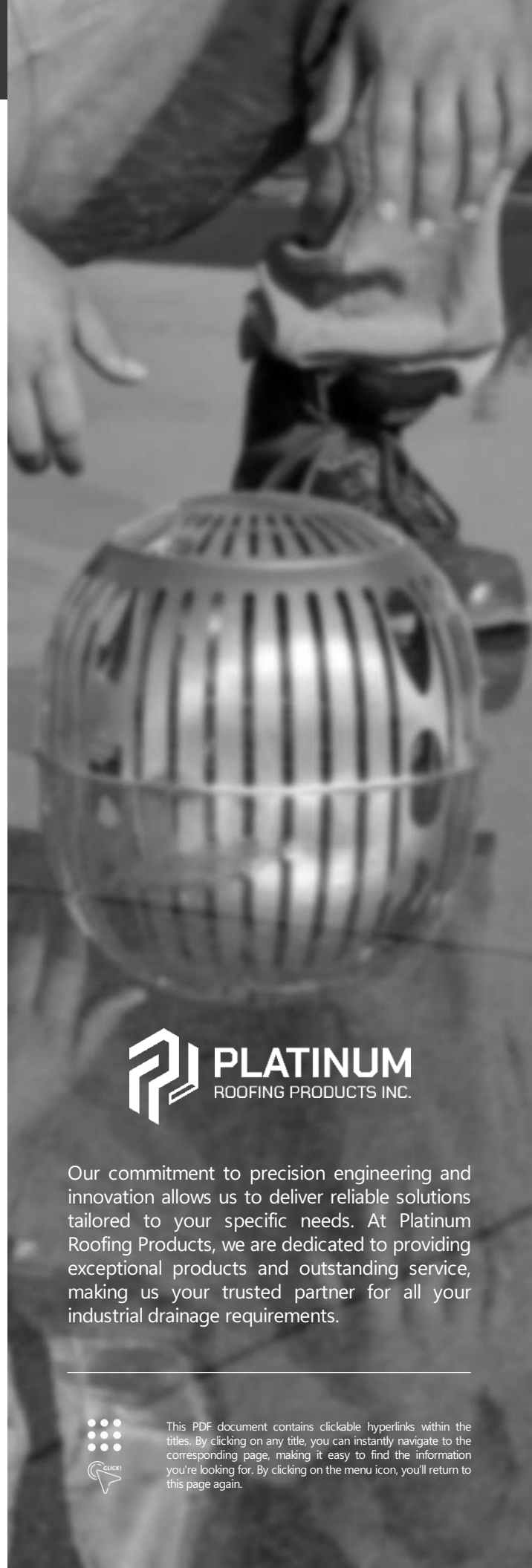

Our commitment to precision engineering and innovation allows us to deliver reliable solutions tailored to your specific needs. At Platinum Roofing Products, we are dedicated to providing exceptional products and outstanding service, making us your trusted partner for all your industrial drainage requirements.



This PDF document contains clickable hyperlinks within the titles. By clicking on any title, you can instantly navigate to the corresponding page, making it easy to find the information you're looking for. By clicking on the menu icon, you'll return to this page again.



Stainless Steel



Retrofit Kit

Recessed Deck (12" Stem)

SKU SIZE

Recessed Deck (22" Stem)

SKU SIZE

Flat Deck (12" Stem)

SKU SIZE

Flat Deck (22" Stem)

SKU SIZE

P-SSF300KIT 3"
P-SSF400KIT 4"
P-SSF500KIT 5"
P-SSF600KIT 6"

P-SS3NRD 3"
P-SS4NRD 4"
P-SS5NRD 5"
P-SS6NRD 6"

P-PAF80175F/2C 1 3/4"
P-PAF80312F/3S 2 3/4"
P-PAF80330F/4S 3 3/4"
P-PAF90357F/5S 4 3/4"
P-PAF90358F/6S 5 3/4"

P-PAFL80312F/3S 2 3/4"
P-PAFL80330F/4S 3 3/4"
P-PAFL90358F/6S 5 3/4"

Aluminum 3-Bolt Series



Retrofit Kit

P-PAR80312/3S 2 3/4"
P-PAR80330/4S 3 3/4"
P-PAR90358/6S 5 3/4"



New Installation Kit

P-PAR90361 3"
P-PAR90362 4"
P-PAR90364 6"

P-PAF80200 2"
P-PAF90361 3"
P-PAF90362 4"
P-PAF90364 6"

Aluminum 4-Bolt Series



Retrofit Kit

MCSAFR3 3"
MCSAFR4 4"
MCSAFR5 5"
MCSAFR6 6"



New Installation Kit

MC3SAFN 3"
MC4SAFN 4"
MC5SAFN 5"
MC6SAFN 6"

Copper 3-Bolt Series



Retrofit Kit

P-P80312/3S 2 3/4"
P-P80330/4S 3 3/4"
P-P90357/5S 4 3/4"
P-P90358/6S 5 3/4"

P-PL80312/3S 2 3/4"
P-PL80330/4S 3 3/4"

P-P80175F/2C 1 3/4"
P-P80312F/3S 2 3/4"
P-P80330F/4S 3 3/4"
P-P90357F/5S 4 3/4"
P-P90358F/6S 5 3/4"

P-PL80312F/3S 2 3/4"
P-PL80330F/4S 3 3/4"
P-PL90358F/6S 5 3/4"



New Installation Kit

P-P90361 3"
P-P90362 4"
P-P90364 6"

P-P80200F 2"
P-P90361F 3"
P-P90362F 4"
P-P90364F 6"

Copper 4-Bolt Series



Retrofit Kit

MCCFR3 3"
MCCFR4 4"
MCCFR5 5"
MCCFR6 6"



New Installation Kit

MCCFN3 3"
MCCFN4 4"
MCCFN5 5"
MCCFN6 6"

Stainless Steel Roof Drains

Retrofit Kit

- Constructed entirely from premium 316L marine-grade Stainless Steel for exceptional durability and corrosion resistance
- Features a vandal-proof Stainless Steel dome lid, easily removable by loosening three screws and twisting off for maintenance access
- Each roof drain comes with a laser-etched QR code on the dome lid, enabling quick registration and access to maintenance history
- Engineered with a 4-stud design for streamlined and efficient installation
- Versatile design accommodates all types of low-slope roofs, suitable for both conventional roof membrane systems (without ballast guard) and inverted roof membrane systems (with ballast guard)
- Compatible with various leader materials, including PVC, cast Iron, Steel, Copper, and more
- Available in flat deck only
- Designed with an 8-degree beveled edge for enhanced adhesion and strength



Standards & Approvals

All Platinum drains are certified by QAI Laboratories to meet **ASME 112.6.4** & **CSA-B79-08** standards, along with **IPC & UPC** codes. They also exceed the **ANSI/SPRI RD-1** national performance standard, which requires the seal to endure a 10-ft. (3 m) water column for 24 hours without any leaks. Manufactured in the USA according to **AS9100/ISO9001** standards, certified partner of Platinum.



Components, Specifications & Quantity

Qty.	Description	Material
1	Stainless Steel Dome Lid	316L Marine-Grade Stainless Steel
1	4-bolt Stainless Steel Dome Strainer	316L Marine-Grade Stainless Steel
1	Stainless Steel Clamping Ring	316L Marine-Grade Stainless Steel
1	Stainless Steel Flow Control	316L Marine-Grade Stainless Steel
1	Stainless Steel Flat Deck Drain With 12" Stem	316L Marine-Grade Stainless Steel
4	3/8 - 16" Knurled-head Thumb Screw	Stainless Steel
8	3/8 - 16" Hex Nut	Stainless Steel
3	#8 1/2" Philips Rounded Head Self Drilling Screws	Stainless Steel

Sizes & Packaging Information

SKU	Deck & Stem Style	Size in. (mm)	Package qty.	Dimensional weight lbs. (Kg)
P-SSF300KIT	Flat	3 (69.80)	1	12.40 (5.62)
P-SSF400KIT	Flat	4 (95.25)	1	12.90 (5.85)
P-SSF500KIT	Flat	5 (120.65)	1	13.40 (6.07)
P-SSF600KIT	Flat	6 (140.05)	1	13.90 (4.08)



REGISTER YOUR DRAIN

Scan the QR code on your drain dome lid, follow the link and allow location permission, fill in the form & register.



To see more details about roof drain components, please check **section 3 – Roof Drain Accessories** of this catalogue.

Please note that PLATINUM products may be periodically updated & are subject to change without prior notice. For additional information, contact PLATINUM ROOFING PRODUCTS at: info@platinumroofingproducts.com





Stainless Steel Roof Drains

New Installation Kit

- Dome, clamping ring, and 18" flat deck are made from premium 316L marine-grade Stainless Steel, paired with a 12" stem (0.040") crafted from durable 304L Stainless Steel
- Features a vandal-proof stainless steel dome lid, easily removable by loosening three screws and twisting off for maintenance access
- Each roof drain comes with a laser-etched QR code on the dome lid, enabling quick registration and access to maintenance history
- Engineered with a 4-stud design for streamlined and efficient installation
- Versatile design accommodates all types of low-slope roofs, suitable for both conventional roof membrane systems (without ballast guard) and inverted roof membrane systems (with ballast guard)
- Compatible with various leader materials, including PVC, cast Iron, Steel, Copper, and more
- Available in flat deck only
- Designed with an 8-degree beveled edge for enhanced adhesion and strength



Standards & Approvals

All Platinum drains are certified by QAI Laboratories to meet **ASME 112.6.4** & **CSA-B79-08** standards, along with **IPC** & **UPC** codes. Manufactured in the USA according to **AS9100/ISO9001** standards, certified partner of Platinum.



Components, Specifications & Quantity

Qty.	Description	Material
1	Stainless Steel Dome Lid	316L Marine-Grade Stainless Steel
1	4-bolt Stainless Steel Dome Strainer	316L Marine-Grade Stainless Steel
1	Stainless Steel Clamping Ring	316L Marine-Grade Stainless Steel
1	Stainless Steel Flow Control	316L Marine-Grade Stainless Steel
1	Stainless Steel Flat Deck Drain With 12" Stem	316L Marine-Grade Stainless Steel, Stem 304L
4	3/8 - 16" Knurled-head Thumb Screw	Stainless Steel
8	3/8 - 16" Hex Nut	Stainless Steel
3	#8 1/2" Philips Rounded Head Self Drilling Screws	Stainless Steel

Sizes & Packaging Information

SKU	Deck & Stem Style	Size in. (mm)	Package qty.	Dimensional weight lbs. (Kg)
P-SS3NRD	Flat	3 (69.80)	1	14.50 (6.57)
P-SS4NRD	Flat	4 (95.25)	1	15.00 (6.80)
P-SS5NRD	Flat	5 (120.65)	1	15.70 (7.12)
P-SS6NRD	Flat	6 (140.05)	1	16.20 (7.34)



REGISTER YOUR DRAIN

Scan the QR code on your drain dome lid, follow the link and allow location permission, fill in the form & register.



To see more details about roof drain components, please check **section 3 – Roof Drain Accessories** of this catalogue.

Aluminum Roof Drains | 3-Bolt Series



Retrofit Kit

- All components made from heavy duty 6063 Aluminum
- Heavy-duty cast Aluminum flip-top dome with a powder-coated finish
- Each roof drain comes with a laser-etched QR code on the dome lid, enabling quick registration and access to maintenance history
- Engineered with a 3-stud design for streamlined and efficient installation
- Versatile design accommodates all types of low-slope roofs, suitable for both conventional roof membrane systems (without ballast guard) and inverted roof membrane systems (with ballast guard)
- Available in either flat or recessed deck
- Both decks are designed with an 8-degree beveled edge for better adhesion and added strength



Standards & Approvals

All Platinum drains are certified by QAI Laboratories to meet **ASME 112.6.4** & **CSA-B79-08** standards, along with **IPC & UPC** codes. They also exceed the **ANSI/SPRI RD-1** national performance standard, which requires the seal to endure a 10-ft. (3 m) water column for 24 hours without any leaks.



Components, Specifications & Quantity

Qty.	Description	Material
1	Heavy Duty Cast Aluminum Flip-top Dome Lid	Cast Aluminum
1	Heavy Duty 3-bolt Cast Aluminum Dome Strainer	Cast Aluminum
1	Heavy Duty Aluminum Clamping Ring	Cast Aluminum
1	Premium Aluminum Flat/Recessed Deck Drain With Stem	Heavy Duty 6063 Aluminum
3	3/8 - 16" X 2.25" UNC Stud	6061 Aluminum
6	3/8 - 16" Hex Nut	Stainless Steel
1	#8 1/2" Philips Rounded Head Self Drilling Screws	Stainless Steel

Sizes & Packaging Information

SKU	Deck & Stem Style	Size in. (mm)	Package Qty.	Dimensional Weight Lbs. (Kg)
P-PAR80312/3S	Recessed	2 3/4 (69.80)	1	8.81 (4.00)
P-PAR80330/4S	Recessed	3 3/4 (95.25)	1	9.25 (4.20)
P-PAR90358/6S	Recessed	5 3/4 (140.05)	1	9.70 (4.40)
P-PAF80175/2C	Flat	1 3/4 (44.45)	1	8.37 (3.80)
P-PAF80312/3S	Flat	2 3/4 (69.80)	1	8.81 (4.00)
P-PAF80330/4S	Flat	3 3/4 (95.25)	1	9.25 (4.20)
P-PAF90357/5S	Flat	4 3/4 (120.65)	1	9.70 (4.40)
P-PAF90358/6S	Flat	5 3/4 (140.05)	1	9.70 (4.40)
P-PAFL80312/3S	Flat - 22" Stem	2 3/4 (69.80)	1	19.10 (8.70)
P-PAFL80330/4S	Flat - 22" Stem	3 3/4 (95.25)	1	9.20 (20.20)
P-PAFL90358/6S	Flat - 22" Stem	5 3/4 (140.05)	1	8.38 (18.40)



REGISTER YOUR DRAIN

Scan the QR code on your drain dome lid, follow the link and allow location permission, fill in the form & register.



To see more details about roof drain components, please check **section 3 - Roof Drain Accessories** of this catalogue.

Please note that PLATINUM products may be periodically updated & are subject to change without prior notice. For additional information, contact PLATINUM ROOFING PRODUCTS at: info@platinumroofingproducts.com



Aluminum Roof Drains | 3-Bolt Series

New Installation Kit

- All components made from heavy duty 6063 Aluminum
- Heavy-duty cast Aluminum flip-top dome with a powder-coated finish
- Each roof drain comes with a laser-etched QR code on the dome lid, enabling quick registration and access to maintenance history
- Engineered with a 3-stud design for streamlined and efficient installation
- Versatile design accommodates all types of low-slope roofs, suitable for both conventional roof membrane systems (without ballast guard) and inverted roof membrane systems (with ballast guard)
- Available in either flat or recessed deck
- Both decks are designed with an 8-degree beveled edge for better adhesion and added strength



Standards & Approvals

All Platinum drains are certified by QAI Laboratories to meet **ASME 112.6.4 & CSA-B79-08** standards, along with **IPC & UPC** codes.



Components, Specifications & Quantity

Qty.	Description	Material
1	Heavy Duty Cast Aluminum Flip-top Dome Lid	Cast Aluminum
1	Heavy Duty 3-bolt Cast Aluminum Dome Strainer	Cast Aluminum
1	Heavy Duty Aluminum Clamping Ring	Cast Aluminum
1	Premium Aluminum Flat/Recessed Deck Drain With Stem	Heavy Duty 6063 T-5 grade Aluminum
3	3/8 - 16" X 2.25" UNC Stud	T-6, 6061 Aluminum
6	3/8 - 16" Hex Nut	Stainless Steel
1	#8 1/2" Philips Rounded Head Self Drilling Screws	Stainless Steel

Sizes & Packaging Information

SKU	Deck & Stem Style	Size in. (mm)	Package qty.	Dimensional weight lbs. (Kg)
P-PAR90361	Recessed	3 (76.20)	1	8.92 (4.05)
P-PAR90362	Recessed	4 (101.60)	1	9.36 (4.25)
P-PAR90364	Recessed	6 (152.40)	1	9.81 (4.45)
P-PAF80200	Flat	2 (50.80)	1	8.81 (4.00)
P-PAF90361	Flat	3 (76.20)	1	8.92 (4.05)
P-PAF90362	Flat	4 (101.60)	1	9.36 (4.25)
P-PAF90364	Flat	6 (152.40)	1	9.81 (4.45)



REGISTER YOUR DRAIN

Scan the QR code on your drain dome lid, follow the link and allow location permission, fill in the form & register.



To see more details about roof drain components, please check **section 3 – Roof Drain Accessories** of this catalogue.

One-Piece Spun Aluminum Roof Drains | 4-Bolt Series



Retrofit Kit

- All components made from heavy duty 1100-0 Aluminum
- Heavy-duty cast Aluminum flip-top dome with a powder-coated finish
- The flip top dome lid can also be entirely removed by unscrewing the hinges which gives 6.5" opening
- Each roof drain comes with a laser-etched QR code on the dome lid, enabling quick registration and access to maintenance history
- Engineered with a 4-stud design for streamlined and efficient installation
- Versatile design accommodates all types of low-slope roofs, suitable for both conventional roof membrane systems (without ballast guard) and inverted roof membrane systems (with ballast guard)
- Available in flat deck only



Standards & Approvals

All Platinum drains are certified by QAI Laboratories to meet **ASME 112.6.4 & CSA-B79-08** standards, along with **IPC & UPC** codes. They also exceed the **ANSI/SPRI RD-1** national performance standard, which requires the seal to endure a 10-ft. (3 m) water column for 24 hours without any leaks.



Components, Specifications & Quantity

Qty.	Description	Material
1	Heavy Duty Cast Aluminum Flip-top Dome Lid	Cast Aluminum
1	Heavy Duty 4-bolt Cast Aluminum Dome Strainer	Cast Aluminum
1	Heavy Duty Aluminum Clamping Ring	Cast Aluminum
1	Spun Aluminum Flow Control Restrictor	Heavy Duty 1100-0 Aluminum
1	Heavy Duty One-piece Spun Aluminum Flat Deck Drain With Stem	Heavy Duty 1100-0 Aluminum
4	3/8 - 16" X 2.25" UNC Stud	6061 Aluminum
8	3/8 - 16" Hex Nut	Stainless Steel
3	#8 1/2" Philips Rounded Head Self Drilling Screws	Stainless Steel

Sizes & Packaging Information

SKU	Deck & Stem Style	Size in. (mm)	Package Qty.	Dimensional Weight Lbs. (Kg)
MCSAFR3	Flat	2 3/4 (69.80)	1	TBD
MCSAFR4	Flat	3 3/4 (95.25)	1	TBD
MCSAFR5	Flat	4 3/4 (120.65)	1	TBD
MCSAFR6	Flat	5 3/4 (140.05)	1	TBD

Please note that PLATINUM products may be periodically updated & are subject to change without prior notice. For additional information, contact PLATINUM ROOFING PRODUCTS at: info@platinumroofingproducts.com



REGISTER YOUR DRAIN

Scan the QR code on your drain dome lid, follow the link and allow location permission, fill in the form & register.



To see more details about roof drain components, please check **section 3 – Roof Drain Accessories** of this catalogue.



One-Piece Spun Aluminum Roof Drains | 4-Bolt Series

New Installation Kit

- All components made from heavy duty 1100-0 Aluminum
- Heavy-duty cast Aluminum flip-top dome with a powder-coated finish
- The flip top dome lid can also be entirely removed by unscrewing the hinges which gives 6.5" opening
- Each roof drain comes with a laser-etched QR code on the dome lid, enabling quick registration and access to maintenance history
- Engineered with a 4-stud design for streamlined and efficient installation
- Versatile design accommodates all types of low-slope roofs, suitable for both conventional roof membrane systems (without ballast guard) and inverted roof membrane systems (with ballast guard)
- Available in flat deck only



Standards & Approvals

All Platinum drains are certified by QAI Laboratories to meet **ASME 112.6.4 & CSA-B79-08** standards, along with **IPC & UPC** codes.



Components, Specifications & Quantity

Qty.	Description	Material
1	Heavy Duty Cast Aluminum Flip-top Dome Lid	Cast Aluminum
1	Heavy Duty 4-bolt Cast Aluminum Dome Strainer	Cast Aluminum
1	Heavy Duty Aluminum Clamping Ring	Cast Aluminum
1	Spun Aluminum Flow Control Restrictor	Heavy Duty 1100-0 Aluminum
1	Heavy Duty One-piece Spun Aluminum Flat Deck Drain With Stem	Heavy Duty 1100-0 Aluminum
4	3/8 - 16" X 2.25" UNC Stud	6061 Aluminum
8	3/8 - 16" Hex Nut	Stainless Steel
3	#8 1/2" Philips Rounded Head Self Drilling Screws	Stainless Steel

Sizes & Packaging Information

SKU	Deck & Stem Style	Size in. (mm)	Package qty.	Dimensional weight lbs. (Kg)
MC3SAFN	Flat	3 (76.20)	1	TBD
MC4SAFN	Flat	4 (101.60)	1	TBD
MC5SAFN	Flat	5 (127.00)	1	TBD
MC6SAFN	Flat	6 (152.40)	1	TBD



REGISTER YOUR DRAIN

Scan the QR code on your drain dome lid, follow the link and allow location permission, fill in the form & register.



To see more details about roof drain components, please check **section 3 – Roof Drain Accessories** of this catalogue.

Copper Roof Drains | 3-Bolt Series

Retrofit Kit

- All components constructed with 24 oz. / 0.05" (1.2mm) prime roofing grade copper for drains up to 3", 1.5mm copper for 5", and 2.0mm copper for 6" drains
- Heavy-duty cast Aluminum flip-top dome with a powder-coated finish
- Each roof drain comes with a laser-etched QR code on the dome lid, enabling quick registration and access to maintenance history
- Engineered with a 3-stud design for streamlined and efficient installation
- Designed for all types of low sloped roofs, suitable for both conventional roof membrane systems (without ballast guard) and inverted roof membrane systems (with ballast guard)
- Available in either flat or recessed deck
- Both decks are designed with an 8-degree beveled edge for better adhesion and added strength



Standards & Approvals

All Platinum drains are certified by QAI Laboratories to meet **ASME 112.6.4** & **CSA-B79-08** standards, along with **IPC** & **UPC** codes. They also exceed the **ANSI/SPRI RD-1** national performance standard, which requires the seal to endure a 10-ft. (3 m) water column for 24 hours without any leaks..



Components, Specifications & Quantity

Qty.	Description	Material
1	Heavy Duty Cast Aluminum Flip-top Dome Lid	Cast Aluminum
1	Heavy Duty 3-bolt Cast Aluminum Dome Strainer	Cast Aluminum
1	Heavy Duty Aluminum Clamping Ring	Cast Aluminum
1	Premium Copper Flat/Recessed Deck Drain With Stem	24 Oz. Prime Roofing Grade Copper
3	3/8 - 16" X 2.25" UNC Stud	Stainless Steel
6	3/8 - 16" Hex Nut	Stainless Steel
3	#8 1/2" Philips Rounded Head Self Drilling Screws	Stainless Steel

Sizes & Packaging Information

SKU	Deck & Stem Style	Size in. (mm)	Package Qty.	Dimensional Weight Lbs. (Kg)
P-P80312/3S	Recessed	2 3/4 (69.80)	1	11.90 (5.40)
P-P80330/4S	Recessed	3 3/4 (95.20)	1	12.50 (5.70)
P-P90357/5S	Recessed	4 3/4 (120.60)	1	9.25 (4.20)
P-P90358/6S	Recessed	5 3/4 (146.00)	1	15.80 (7.20)
P-P80175F/2C	Flat	1 3/4 (44.40)	1	10.36 (4.70)
P-P80312F/3S	Flat	2 3/4 (69.80)	1	11.90 (5.40)
P-P80330F/4S	Flat	3 3/4 (95.20)	1	12.50 (5.70)
P-P90357F/5S	Flat	4 3/4 (120.60)	1	9.25 (4.20)
P-P90358F/6S	Flat	5 3/4 (146.00)	1	15.80 (7.20)
P-PL80312/3S	Recessed - 22" Stem	2 3/4 (69.80)	2	25.00 (11.35)
P-PL80330/4S	Recessed - 22" Stem	3 3/4 (95.20)	2	27.49 (12.47)
P-PL90358/6S	Recessed - 22" Stem	5 3/4 (146.00)	1	15.87 (7.20)
P-PL80312F/3S	Flat - 22" Stem	2 3/4 (69.80)	2	25.00 (11.35)
P-PL80330F/4S	Flat - 22" Stem	3 3/4 (95.20)	2	27.49 (12.47)
P-PL90358F/6S	Flat - 22" Stem	5 3/4 (146.00)	1	15.87 (7.20)



REGISTER YOUR DRAIN

Scan the QR code on your drain dome lid, follow the link and allow location permission, fill in the form & register.



To see more details about roof drain components, please check **section 3 - Roof Drain Accessories** of this catalogue.

Please note that PLATINUM products may be periodically updated & are subject to change without prior notice. For additional information, contact PLATINUM ROOFING PRODUCTS at: info@platinumroofingproducts.com





Copper Roof Drains | 3-Bolt Series

New Installation Kit

- All components constructed with 24 oz. / 0.05" (1.2mm) prime roofing grade copper for drains up to 3", 1.5mm copper for 5", and 2.0mm copper for 6" drains
- Heavy-duty cast Aluminum flip-top dome with a powder-coated finish
- Each roof drain comes with a laser-etched QR code on the dome lid, enabling quick registration and access to maintenance history
- Engineered with a 3-stud design for streamlined and efficient installation
- Designed for all types of low sloped roofs, suitable for both conventional roof membrane systems (without ballast guard) and inverted roof membrane systems (with ballast guard)
- Available in either flat or recessed deck
- Both decks are designed with an 8-degree beveled edge for better adhesion and added strength



Standards & Approvals

All Platinum drains are certified by QAI Laboratories to meet **ASME 112.6.4 & CSA-B79-08** standards, along with **IPC & UPC** codes.



Components, Specifications & Quantity

Qty.	Description	Material
1	Heavy Duty Cast Aluminum Flip-top Dome Lid	Cast Aluminum
1	Heavy Duty 3-bolt Cast Aluminum Dome Strainer	Cast Aluminum
1	Heavy Duty Aluminum Clamping Ring	Cast Aluminum
1	Premium Copper Flat/Recessed Deck Drain With Stem	24 Oz. Prime Roofing Grade Copper
3	3/8 - 16" X 2.25" UNC Stud	Stainless Steel
6	3/8 - 16" Hex Nut	Stainless Steel
3	#8 1/2" Philips Rounded Head Self Drilling Screws	Stainless Steel

Sizes & Packaging Information

SKU	Deck & Stem Style	Size in. (mm)	Package Qty.	Dimensional Weight Lbs. (Kg)
P-P90361	Recessed	3 (76.20)	1	11.90 (5.40)
P-P90362	Recessed	4 (101.60)	1	12.50 (5.70)
P-P90364	Recessed	6 (152.40)	1	12.50 (5.70)
P-P80200F	Flat	2 (50.80)	1	10.90 (4.95)
P-P90361F	Flat	3 (76.20)	1	11.90 (5.40)
P-P90362F	Flat	4 (101.60)	1	12.50 (5.70)
P-P90364F	Flat	6 (152.40)	1	12.50 (5.70)



REGISTER YOUR DRAIN

Scan the QR code on your drain dome lid, follow the link and allow location permission, fill in the form & register.



To see more details about roof drain components, please check **section 3 – Roof Drain Accessories** of this catalogue.

Copper Roof Drains | 4-Bolt Series



Retrofit Kit

- All components constructed with 32 oz. prime roofing grade copper
- Heavy-duty cast Aluminum flip-top dome with a powder-coated finish
- Each roof drain comes with a laser-etched QR code on the dome lid, enabling quick registration and access to maintenance history
- Engineered with a 4-stud design for streamlined and efficient installation
- Versatile design accommodates all types of low-slope roofs, suitable for both conventional roof membrane systems (without ballast guard) and inverted roof membrane systems (with ballast guard)
- Available in flat deck only
- Designed with an 8-degree beveled edge for enhanced adhesion and strength



Standards & Approvals

All Platinum drains are certified by QAI Laboratories to meet **ASME 112.6.4** & **CSA-B79-08** standards, along with **IPC** & **UPC** codes. They also exceed the **ANSI/SPRI RD-1** national performance standard, which requires the seal to endure a 10-ft. (3 m) water column for 24 hours without any leaks.



Components, Specifications & Quantity

Qty.	Description	Material
1	Heavy Duty Cast Aluminum Flip-top Dome Lid	Cast Aluminum
1	Heavy Duty 4-bolt Cast Aluminum Dome Strainer	Cast Aluminum
1	Heavy Duty Aluminum Clamping Ring	Cast Aluminum
1	Premium Copper Flat Deck Drain With Stem	32 Oz. Prime Roofing Grade Copper
4	3/8 - 16" X 2.25" UNC Stud	Stainless Steel
8	3/8 - 16" Hex Nut	Stainless Steel
3	#8 1/2" Philips Rounded Head Self Drilling Screws	Stainless Steel

Sizes & Packaging Information

SKU	Deck & Stem Style	Size in. (mm)	Package Qty.	Dimensional Weight Lbs. (Kg)
MCCFR3	Flat	3 (76.20)	1	11.46 (5.20)
MCCFR4	Flat	4 (101.60)	1	12.12 (5.50)
MCCFR5	Flat	5 (127.00)	1	TBD
MCCFR6	Flat	6 (152.40)	1	14.77 (6.70)



REGISTER YOUR DRAIN

Scan the QR code on your drain dome lid, follow the link and allow location permission, fill in the form & register.



To see more details about roof drain components, please check **section 3 – Roof Drain Accessories** of this catalogue.

Please note that PLATINUM products may be periodically updated & are subject to change without prior notice. For additional information, contact PLATINUM ROOFING PRODUCTS at: info@platinumroofingproducts.com



Copper Roof Drains | 4-Bolt Series

New Installation Kit

- All components constructed with 32 oz. prime roofing grade copper
- Heavy-duty cast Aluminum flip-top dome with a powder-coated finish
- Each roof drain comes with a laser-etched QR code on the dome lid, enabling quick registration and access to maintenance history
- Engineered with a 4-stud design for streamlined and efficient installation
- Versatile design accommodates all types of low-slope roofs, suitable for both conventional roof membrane systems (without ballast guard) and inverted roof membrane systems (with ballast guard)
- Available in flat deck only
- Designed with an 8-degree beveled edge for enhanced adhesion and strength



Standards & Approvals

All Platinum drains are certified by QAI Laboratories to meet **ASME 112.6.4 & CSA-B79-08** standards, along with **IPC & UPC** codes.



Components, Specifications & Quantity

Qty.	Description	Material
1	Heavy Duty Cast Aluminum Flip-top Dome Lid	Cast Aluminum
1	Heavy Duty 4-bolt Cast Aluminum Dome Strainer	Cast Aluminum
1	Heavy Duty Aluminum Clamping Ring	Cast Aluminum
1	Premium Copper Flat Deck Drain With Stem	32 Oz. Prime Roofing Grade Copper
4	3/8 - 16" X 2.25" UNC Stud	Stainless Steel
8	3/8 - 16" Hex Nut	Stainless Steel
3	#8 1/2" Philips Rounded Head Self Drilling Screws	Stainless Steel

Sizes & Packaging Information

SKU	Deck & Stem Style	Size in. (mm)	Package Qty.	Dimensional Weight Lbs. (Kg)
MCCFN3	Flat	3 (76.20)	1	11.90 (5.40)
MCCFN4	Flat	4 (101.60)	1	12.56 (5.70)
MCCFN5	Flat	5 (127.00)	1	TBD
MCCFN6	Flat	6 (152.40)	1	TBD



REGISTER YOUR DRAIN

Scan the QR code on your drain dome lid, follow the link and allow location permission, fill in the form & register.



To see more details about roof drain components, please check **section 3 – Roof Drain Accessories** of this catalogue.



Aluminum



Economy



Economy



Economy



Temporary

Copper



Economy



Temporary

Flat Deck (6" Stem)

SKU SIZE

P-EAFLAT-275 2 3/4"

P-EAFUN-275 2 3/4"

Flat Deck (12" Stem)

SKU SIZE

P-EA13010 2 3/4"
P-EA13011 3 3/4"
P-EA300 3"
P-EA400 4"

P-TEMPFA-275 2 3/4"
P-TEMPFA-375 3 3/4"

P-EC13010 2 3/4"
P-EC13011 3 3/4"

P-P80312QC-12 2 3/4"
P-P80330QC-12 3 3/4"

Flat Deck (18" Stem)

SKU SIZE

P-80312QC-18 2 3/4"
P-80330QC-18 3 3/4"

Aluminum Roof Drains

Economy

- One-piece spun Aluminum flat deck drain featuring a 14" flange
- Constructed with a 1.6mm thickness for both the stem and deck
- Spot-welded Aluminum drainage collar secured with 2 screws to fasten the strainer
- Complete with a TPO drain dome and 2 screws for easy installation
- 12" drain stem length for versatile application

Sizes & Packaging Information

SKU	Deck & Stem Style	Size in. (mm)	Package Qty.	Dimensional Weight Lbs. (Kg)
P-EA13010	Flat – 12" Stem	2 ¾ in. (69.80)	5	1.410 (0.64)
P-EA13011	Flat – 12" Stem	3 ¾ in. (95.20)	5	1.68 (0.76)
P-EA300	Flat – 12" Stem	3 in. (76.20)	5	1.49 (0.68)
P-EA400	Flat – 12" Stem	4 in. (101.60)	5	1.48 (0.67)

Economy – 6" Stem

- One-piece spun Aluminum available in 2 ¾" stem diameter either in flat deck or funnel deck drain
- featuring wide deck to enhance coverage
- Constructed with a 1.6 mm material thickness
- 6" long drain stem
- Designed to fit drain seal inserts

Sizes & Packaging Information

SKU	Deck & Stem Style	Size in. (mm)	Package Qty.	Dimensional Weight Lbs. (Kg)
P-EAFLAT-275	Flat – 6" Stem	2 ¾ (69.80)	5	1.49 (0.68)
P-EAFUN-275	Flat – 6" Stem	2 ¾ (69.80)	5	1.55 (0.70)

Application

Economy drains are designed for cost-effective drainage solutions in roofing applications. They facilitate the efficient removal of water from roofs, preventing pooling and potential water damage. Typically used in commercial or low-budget projects, economy drains are lightweight and easy to install, making them suitable for both new constructions and retrofitting existing systems. Their affordability does not compromise performance, as they still meet necessary drainage requirements, helping to maintain the longevity and integrity of the roofing system.

Temporary

- One-piece spun Aluminum flat deck drain with a 14" flange
- Features a 1.6mm thickness for both the stem and deck
- 12" drain stem length for versatile application
- Ideal for temporary use in various drainage situations

Sizes & Packaging Information

SKU	Deck & Stem Style	Size in. (mm)	Package Qty.	Dimensional Weight Lbs. (Kg)
P-TEMPFA-275	Flat – 12" Stem	2 ¾ (69.90)	5	1.32 (0.60)
P-TEMPFA-375	Flat – 12" Stem	3 ¾ (95.30)	5	1.37 (0.62)

Application

Temporary drains are used in roofing applications to manage water runoff during construction or maintenance. They help prevent water accumulation on the roof, reducing the risk of leaks, structural damage, and safety hazards. Temporary drains are particularly useful in areas where permanent drainage systems are not yet installed or when immediate water removal is necessary. Their easy installation and removal make them ideal for protecting roofing materials and ensuring a safe working environment.



P-EAFLAT-275

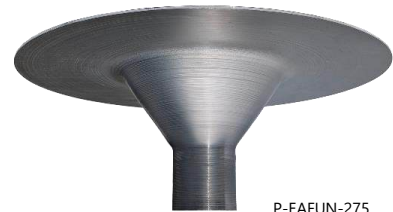

P-EAFUN-275





Copper Roof Drains

Economy

- Ideal for temporary connections in various drainage applications
- 0.75mm thickness for the drain deck and 1.2mm thickness for the drain stem, ensuring durability and strength
- Complete with a TPO drain dome and two screws for easy installation
- 12" stem welded securely to the drain deck, featuring a 14" wide copper flange for reliable connections
- Copper drainage collar spot-welded to the deck for added durability

Sizes & Packaging Information

SKU	Deck & Stem Style	Size in. (mm)	Package Qty.	Dimensional Weight Lbs. (Kg)
P-EC13010	Flat – 12" Stem	2 ¾ (69.80)	5	3.13 (1.42)
P-EC13011	Flat – 12" Stem	3 ¾ (95.20)	5	4.09 (1.86)

Application

Economy drains are designed for cost-effective drainage solutions in roofing applications. They facilitate the efficient removal of water from roofs, preventing pooling and potential water damage. Typically used in commercial or low-budget projects, economy drains are lightweight and easy to install, making them suitable for both new constructions and retrofitting existing systems. Their affordability does not compromise performance, as they still meet necessary drainage requirements, helping to maintain the longevity and integrity of the roofing system.



Temporary

- Ideal for reusable temporary drains in various applications
- Constructed with a 0.75mm thickness for the copper deck and 1.2mm thickness for the copper stem for durability
- Two-piece construction with argon arc welded stem and deck, offering strong, secure connections
- Available with 2¾" and 3¾" drain stems in 12" and 18" lengths, and a 14.76" wide drain deck for versatile installation options
- Designed to fit 3" and 4" drain inserts, ensuring compatibility with a variety of systems
- Flat deck style for easy installation

Sizes & Packaging Information

SKU	Deck & Stem Style	Size in. (mm)	Package Qty.	Dimensional Weight Lbs. (Kg)
P-80312QC-12	Flat – 12" Stem	2 ¾ (69.80)	5	3.67 (1.66)
P-80330QC-12	Flat – 12" Stem	3 ¾ (95.20)	5	4.00 (1.81)
P-80312QC-18	Flat – 18" Stem	2 ¾ (69.80)	5	4.27 (1.94)
P-80330QC-18	Flat – 18" Stem	3 ¾ (95.20)	5	4.97 (2.25)

Application

Temporary drains are used in roofing applications to manage water runoff during construction or maintenance. They help prevent water accumulation on the roof, reducing the risk of leaks, structural damage, and safety hazards. Temporary drains are particularly useful in areas where permanent drainage systems are not yet installed or when immediate water removal is necessary. Their easy installation and removal make them ideal for protecting roofing materials and ensuring a safe working environment.





3-Bolt & 4-Bolt Copper & Aluminum Drains



Drain Seals

SKU	SIZE
P-3S-12	3"
P-4S-12	4"
P-5S-12	5"
P-6S-12	6"



3-Bolt Aluminum Drain Dome Strainer

SKU: P-12022
What's included(Quantity):
#8 1/2" Stainless Steel Phillips rounded head self drilling screw(1)

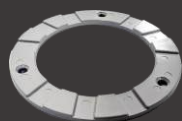

3-Bolt Aluminum Clamping Ring

SKU: P-90146



4-Bolt Aluminum Drain Dome Strainer

SKU: P170515
What's included(Quantity):
#8 1/2" Stainless Steel Phillips rounded head self drilling screw(1)

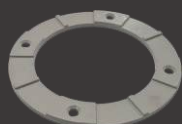

4-Bolt Aluminum Clamping Ring

SKU: P170529



Spun Aluminum Flow Control Restrictor

SKU: P10181

Stainless Steel Drains



Stainless Steel Dome Strainer

SKU: P-SSDOME
What's included(Quantity):
#8 1/2" Stainless Steel Phillips rounded head self drilling screw(3)

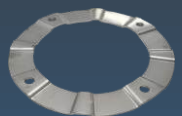

Stainless Steel Clamping Ring

SKU: P-SSFLANGE

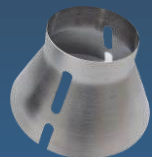

Stainless Steel Flow Control Restrictor

SKU: P-SSFLOWCONTROL

Economy

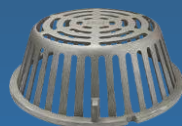

TPO Drain Dome (Economy Drains Only)

What's included(Quantity):
#8 1/2" Stainless Steel Phillips rounded head self drilling screw(2)

Drain seals

Retrofit

Platinum mechanical seals are expertly designed to provide a reliable, watertight connection between roof drain stems and existing plumbing drains while being versatile enough to fit different drain configurations, ensuring a dependable and long-lasting solution to prevent leaks and maintain effective drainage. Constructed from premium Nylon and EPDM Rubber, these seals offer exceptional durability and resistance to environmental conditions. Their strength is further reinforced by stainless steel screws, ensuring high performance across various applications. Available in sizes ranging from 3 to 6 inches.



Features

- Easy to install
- Provides a watertight seal to prevent damage from water backup
- Compatible with Aluminum, Stainless Steel, & Copper retrofit drains

Standards & Approvals

ANSI/SPRI RD-1 is a national performance standard for retrofit roof drains. Although most retrofit drains are not tested to this standard, Platinum insert drains surpass it. The standard requires that the seal withstand a 10-foot column of water for 24 hours without any leakage.



Sizes & Packaging Information

SKU	Size in. (mm)	Package Qty.	Dimensional Weight Lbs. (Kg)
P-3S-12	3 (76.20)	1	0.44 (0.20)
P-4S-12	4 (101.60)	1	0.77 (0.35)
P-5S-12	5 (127.00)	1	0.80 (0.36)
P-6S-12	6 (152.40)	1	1.00 (0.45)

Physical Data

Seal Size (in.)	Small End O.D. (in.)	Large End O.D. (in.)	Large End Min. Expansion (in.)
3	2.62±0.001	2.87±0.001	>3.34
4	3.50±0.002	3.74±0.001	>4.13
5	4.55±0.002	4.81±0.002	>5.39
6	5.44±0.002	5.76±0.002	>6.22

Please note that PLATINUM products may be periodically updated & are subject to change without prior notice. For additional information, contact PLATINUM ROOFING PRODUCTS at: info@platinumroofingproducts.com





Drain Domes

Aluminum | 3-Bolt

- Heavy duty die-cast powder coated Aluminum dome, crafted for maximum corrosion resistance
- Compatible with all 3-Bolt Aluminum and Copper drains
- Each roof drain comes with a laser-etched QR code on the dome lid, enabling quick registration and access to maintenance history
- Features 33 weir slots for maximum water flow
- Easy maintenance facilitated by a single Phillips screw
- 3-bolt design ensures efficient installation
- Vandal-resistant yet contractor-friendly for ease of use

Sizes & Packaging Information

SKU	Diameter Size in. (mm)	Package Qty.	Dimensional Weight Lbs. (Kg)
P-12022	10 3/8 (264.00)	1	3.60 (1.64)



Aluminum | 4-Bolt

- Heavy duty die-cast powder coated Aluminum dome, crafted for maximum corrosion resistance
- Compatible with all 4-Bolt Aluminum and Copper drains
- Each roof drain comes with a laser-etched QR code on the dome lid, enabling quick registration and access to maintenance history
- Features a flip-top lid that can be removed entirely by unscrewing the hinge screws which gives a total of 6.5" opening
- Features 40 weir slots for maximum water flow
- Easy maintenance facilitated by a single Phillips screw
- Vandal-resistant yet contractor-friendly for ease of use

Sizes & Packaging Information

SKU	Diameter Size in. (mm)	Package Qty.	Dimensional Weight Lbs. (Kg)
P-170515	10 3/8 (264.00)	1	2.00 (0.91)



Stainless Steel

- Heavy-duty formed stainless steel dome, crafted from 316L marine-grade stainless steel for maximum corrosion resistance
- Features a removable lid that can be twisted off by loosening just three screws
- Each roof drain comes with a laser-etched QR code on the dome lid, enabling quick registration and access to maintenance history
- Includes keyed holes for easy and quick dome installation & removal without the need to remove nuts
- The design incorporates 33 weir slots to ensure maximum water flow
- Vandal-resistant design, making it durable and reliable
- Contractor-friendly for simplified installation and maintenance

Sizes & Packaging Information

SKU	Diameter Size in. (mm)	Package Qty.	Dimensional Weight Lbs. (Kg)
P-SSDOME	10 3/8 (264.00)	1	2.05 (0.93)



Application

Dome strainers in roof drains prevent debris, such as leaves and twigs, from clogging the drainage system while allowing water to flow freely. They help maintain optimal drainage, protect plumbing from damage, and enhance safety by reducing the risk of standing water on the roof surface. Additionally, the removable lid facilitates easy maintenance, allowing for quick cleaning and inspection of the strainer without dismantling the entire system.



Clamping Rings (Flanges)

Aluminum | 3-Bolt

- Heavy duty die-cast Aluminum with powder coated Aluminum construction for durability
- Features 9 drainage channels to allow for full drainage
- Flange designed for an optimum seal with roof flashing
- Compatible with all 3-Bolt Aluminum and Copper drains
- Reversible design allows for elevation drainage options

Sizes & Packaging Information

SKU	Diameter Size in. (mm)	Package Qty.	Dimensional Weight Lbs. (Kg)
P-90146	10 3/8 (264.00)	1	1.28 (0.58)



Aluminum | 4-Bolt

- Heavy duty die-cast powder coated Aluminum construction for maximum durability
- Features 8 drainage channels to allow for full drainage
- Flange designed for an optimum seal with roof flashing
- Compatible with all 4-Bolt Aluminum and Copper drains
- Reversible design allows for elevation drainage options

Sizes & Packaging Information

SKU	Diameter Size in. (mm)	Package Qty.	Dimensional Weight Lbs. (Kg)
P-170529	10 3/8 (264.00)	1	1.25 (0.57)



Stainless Steel

- Heavy Duty Formed Stainless Steel Manufactured from marine grade 316L Stainless Steel with maximum corrosion resistance
- Features 8 drainage channels to allow for full drainage
- Flange designed for an optimum seal with roof flashing
- Compatible with all Stainless Steel drains
- Reversible design allows for elevation drainage options

Sizes & Packaging Information

SKU	Diameter Size in. (mm)	Package Qty.	Dimensional Weight Lbs. (Kg)
P-SSFLANGE	10 3/8 (264.00)	1	0.56 (0.25)

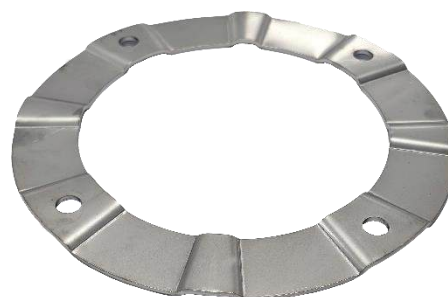

Application

Clamping rings in roof drains serve to secure the drain assembly firmly to the roof structure, ensuring a watertight seal. They help maintain the stability of the drain by preventing movement caused by thermal expansion, contraction, or environmental factors. By effectively compressing the roofing membrane against the drain, clamping rings minimize the risk of leaks and water infiltration. Additionally, they facilitate easy installation and maintenance of the roof drain system, contributing to the overall durability and performance of the roofing system.

Please note that PLATINUM products may be periodically updated & are subject to change without prior notice. For additional information, contact PLATINUM ROOFING PRODUCTS at: info@platinumroofingproducts.com



Flow Control Restrictors

Aluminum

- Simple & easy to install
- Fits all styles & sizes of Platinum drains
- Drainage flutes are located on both sides and a 4" diameter top opening when head of water exceeds 4.41" flow control height
- Side drainage flutes designed to restrict water flow and comply to municipal regulations
- constructed from Heavy Duty 1100-O Aluminum
- QAI laboratories tested

Sizes & Packaging Information

SKU	Package Qty.	Dimensional Weight Lbs. (Kg)
P-10181	1	0.41 (0.19)



Stainless Steel

- Simple & easy to install
- Fits all styles & sizes of Platinum drains
- Drainage flutes are located on both sides and a 4" diameter top opening when head of water exceeds 4.41" flow control height
- Side drainage flutes designed to restrict water flow and comply to municipal regulations
- Made out of heavy gauge 316L marine-grade Stainless Steel
- QAI laboratories tested

Sizes & Packaging Information

SKU	Package Qty.	Dimensional Weight Lbs. (Kg)
P-SSFLOWCONTROL	1	0.56 (0.258)



Application

Flow control restrictors in roof drains regulate the rate of water drainage, preventing overflow and managing storm water runoff. They help maintain a consistent water flow, which is essential for avoiding excessive ponding on roofs. By controlling drainage rates, flow restrictors minimize the risk of water damage and structural issues, ensuring the roof's integrity over time.

Performance Data

Water Head Level	Flow Control (GPM)
0"	Minimal Flow
1" Head of water	8 GPM
2" Head of water	12 GPM
3" Head of water	20 GPM
4" Head of water	30 GPM

Add-ons

Stainless Steel Ballast Guard

- Manufactured from premium 304 grade, 22 gauge Stainless Steel for superior durability and corrosion resistance
- Folded top and bottom edges ensure safe handling and easy installation
- Platinum-engineered unique clip design offers secure and flexible size adjustment
- Accommodates dome diameters from 10 1/2" to 12 1/2" for a perfect fit
- Convenient packaging with 10 pieces per box, making transport and storage easier
- Features 3 integral clips for quick and secure installation
- Precision machine-drilled 6 mm holes cover 28% of the surface area, providing optimal drainage for inverted roofs

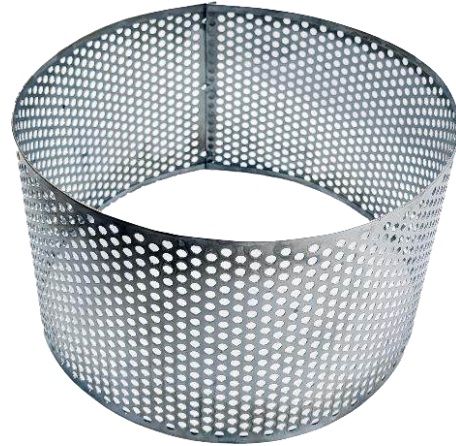

Sizes & Packaging Information

SKU	Diameter Size in. (mm)	Package Qty.	Dimensional Weight Lbs. (Kg)
P-12061	10 1/2 (266.70)	10	1.89 (0.86)

Application

Designed for use in protected membrane (inverted) roof assemblies, where it effectively prevents loose ballast from accumulating against the strainer. It also safeguards against any ballast falling through the strainer, ensuring proper drainage and maintaining the integrity of the roofing system. By facilitating a balanced distribution of ballast, this solution contributes to the overall stability and longevity of the roof assembly.

Under Deck Clamp

- Constructed from premium heavy-gauge Aluminum measuring 1" wide, 18" long, and 4.7mm thick for enhanced durability
- Specifically designed for compatibility with 3", 4" & 6" new construction drains
- Tested to withstand over 300 lb. pull force, ensuring reliable performance
- Each set includes 2 Allen key bolts and nuts for secure installation



Sizes & Packaging Information

SKU	Diameter Size in. (mm)	Package Qty.	Dimensional Weight Lbs. (Kg)
P-X13012	3 (76.20)	5	0.69 (0.31)
P-X13013	4 (101.60)	5	0.75 (0.34)
P-X13014	6 (152.40)	5	0.79 (0.36)

Application

Under deck clamps are essential for ensuring a secure and durable installation of roof drains, particularly in all installations except poured-in-place setups. Properly securing the roof drains with under-deck clamps is crucial; without them, the drains may shift due to snow and rain loads, as well as the natural expansion and contraction of materials. This movement can lead to flexing and eventual failure of the roofing membranes.

Overall Dimensions

SKU	Size (in.)	Dim. "A" Length (in.)	Dim. "B" Width (in.)	Dim. "C" Diameter (in.)
P-X13012	3	17 7/8	6 1/4	3
P-X13013	4	17 7/8	5 13/16	3 15/16
P-X13014	6	17 7/8	4 7/8	6

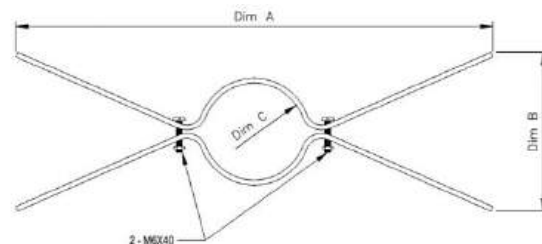

Please note that PLATINUM products may be periodically updated & are subject to change without prior notice. For additional information, contact PLATINUM ROOFING PRODUCTS at: info@platinumroofingproducts.com



Rain Collars

Galvanized Metal Rain Collars

- Economical rain collar constructed from 25 gauge galvanized metal (26 gauge for 2" size only)
- Features 2" of overlap for flexible adjustment across various pipe sizes
- Available in a wide range of sizes from 2" to 24" diameter
- Overlapping inner plate allows for adjustment of up to +1" to accommodate larger pipe diameters
- Provides space for Silicone seal at the upper edge where the collar is tightened to the pipe, ensuring a secure fit
- Conveniently packaged in boxes that match the quantity of Platinum tall cones for easy integration



Application

Rain collars are used to create a watertight seal around vent pipes or other roof penetrations. Installed above the pipe flashing, it helps prevent water from seeping through the gap between the pipe and the flashing, protecting the roof system from leaks.

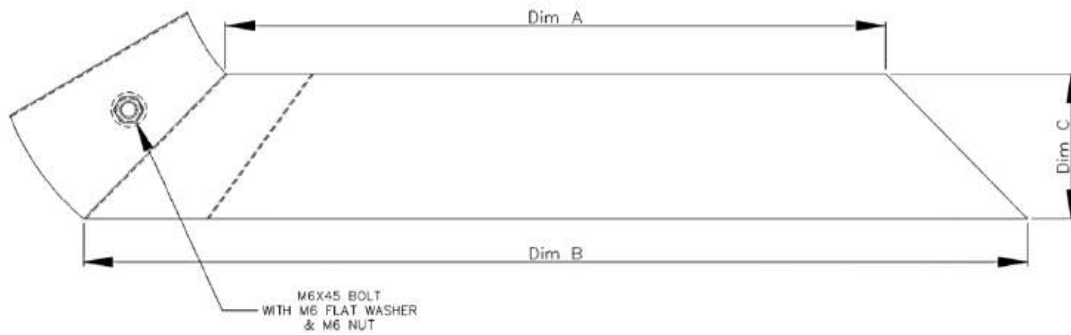

Sizes & Packaging Information

SKU	Size (in.)	Dim. "A" Top I.D. (in.)	Dim. "B" Bottom I.D. (in.)	Dim. "C" Total Height (in.)	Package Qty.	Dimensional Weight Lbs. (Kg)
P-SMRC2	2	1 ³¹ / ₃₂	5 ¹³ / ₁₆	1 ³¹ / ₃₂	25	0.24 (0.11)
P-SMRC-3	3	2 ¹⁵ / ₁₆	6 ³ / ₄	1 ³¹ / ₃₂	25	0.32 (0.15)
P-SMRC-4	4	4 ¹ / ₃₂	7 ⁷ / ₈	1 ³¹ / ₃₂	25	0.37 (0.17)
P-SMRC-5	5	4 ¹⁵ / ₁₆	8 ³ / ₄	1 ³¹ / ₃₂	25	0.45 (0.20)
P-SMRC-6	6	5 ¹⁵ / ₁₆	9 ³ / ₄	1 ³¹ / ₃₂	25	0.46 (0.21)
P-SMRC-7	7	6 ⁷ / ₈	10 ⁷ / ₈	2 ¹ / ₁₆	10	0.49 (0.22)
P-SMRC-8	8	7 ¹⁵ / ₁₆	11 ³ / ₄	1 ³¹ / ₃₂	10	0.55 (0.25)
P-SMRC-9	9	8 ¹⁵ / ₁₆	12 ¹³ / ₁₆	1 ³¹ / ₃₂	10	0.57 (0.26)
P-SMRC-10	10	9 ¹⁵ / ₁₆	13 ¹³ / ₁₆	1 ³¹ / ₃₂	10	0.58 (0.26)
P-SMRC-11	11	11 ¹ / ₁₆	14 ¹⁵ / ₁₆	1 ³¹ / ₃₂	10	0.71 (0.32)
P-SMRC-12	12	11 ¹⁵ / ₁₆	15 ²⁵ / ₃₂	1 ³¹ / ₃₂	10	0.72 (0.33)
P-SMRC-14	14	13 ¹⁵ / ₁₆	17 ²⁵ / ₃₂	1 ³¹ / ₃₂	5	0.79 (0.36)
P-SMRC-16	16	15 ¹⁵ / ₁₆	19 ²⁵ / ₃₂	1 ³¹ / ₃₂	5	0.91 (0.41)
P-SMRC-18	18	17 ⁷ / ₈	21 ³ / ₄	1 ³¹ / ₃₂	5	0.01 (0.46)
P-SMRC-20	20	18 ¹³ / ₁₆	23 ⁵ / ₈	1 ³¹ / ₃₂	5	1.25 (0.57)
P-SMRC-22	22	21 ⁷ / ₈	26 ¹¹ / ₁₆	2 ⁷ / ₁₆	5	1.38 (0.63)
P-SMRC-24	24	23 ⁷ / ₈	28 ¹¹ / ₁₆	2 ⁷ / ₁₆	5	2.84 (1.29)



Electrical Flashings



Cobra-Head Electrical Flashings

SKU	SIZE
P-12099W	12"
P-12099-18	18"



Gooseneck Electrical Flashing

SKU: P-12100



4-Nipple Electrical Flashing

SKU: P-EF4N

What's included(Quantity):
EPDM Rubber Boot(1)
MJ Clamping Rings(5)

Roof Anchor Flashings



Roof Anchor Flashing

SKU: P-RAF500

What's included(Quantity):
EPDM Rubber Boot(1)
MJ Clamping Rings(5)



Roof Anchor Plate Flashing

SKU: P-RAPF500-W

What's included(Quantity):
EPDM Rubber Boot(1)
MJ Clamping Rings(5)

EPDM Rubber Boots



4-Nipple EPDM Rubber Boot

SKU: P-4RB



EPDM Rubber Boot

SKU: P-5RB



Electrical Flashings

Cobra Head Flashings

- Spun Aluminum bases available in two heights: 12" high with a removable 3-piece PVC head for an overall height of 15", and 18" high with a removable 3-piece PVC head for an overall height of 21"
- PVC head accommodates up to 4 shielded electrical cables, ensuring a weather-tight seal
- Factory insulated base featuring 3/4" thickness Polyurethane foam for enhanced thermal efficiency
- 2" inner diameter between the insulation walls for ample conduit space
- 11 1/2" wide flange on the base of the flashing for secure installation



Sizes & Packaging Information

SKU	Diameter Size in. (mm)	Package Qty.	Dimensional Weight Lbs. (Kg)	Dim. "A" Base Height (in.)	Dim. "B" Total Height (in.)	Dim. "C" Diameter (in.)
P-12099W	12 (304.80)	5	1.70 (0.77)	12	15	13 11/16
P-12099-18	18 (457.20)	5	1.95 (0.88)	18	21	13 11/16

Application

Electrical flashing in the roofing industry is crucial for creating a weather-tight seal around electrical conduits and service entries. Made from durable materials like rubber and spun Aluminum, it prevents water infiltration, safeguarding electrical systems and maintaining roof integrity. Proper installation minimizes leak risks and ensures compliance with building codes, enhancing the longevity of the roofing system. PVC head accommodates up to 4 shielded electrical cables.

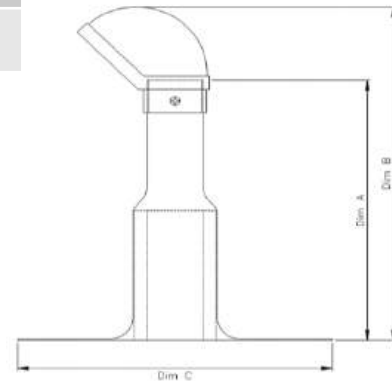

Gooseneck Flashing

- Heavy-duty Spun Aluminum base featuring a 4" deck flange and an 11 1/2" total flashing base diameter
- Premium grade 304 Stainless Steel gooseneck, 30" in height, securely attached to the base with rivets
- Stainless Steel walls with a thickness of 1 mm and an outer diameter of 50 mm
- Insulated Spun Aluminum base with 3/4" thickness walls for improved energy efficiency
- 1 3/4" inner diameter between the insulated walls for adequate conduit space
- Gooseneck design ensures weatherproof flashing for extending wiring conduits on low-slope roof systems
- Provides convenient electrical access wherever needed on the roof
- Insulated walls made from 3/4" thickness Polyurethane foam for enhanced thermal protection
- Ideal for satellite cable penetrations, ensuring reliable performance



Application

Made from durable materials like Stainless Steel and spun Aluminum, it prevents water infiltration, safeguarding electrical systems and maintaining roof integrity. Proper installation minimizes leak risks and ensures compliance with building codes, enhancing the longevity of the roofing system. Ideal for satellite cable penetrations. Gooseneck design provides a weatherproof flashing for extending wiring conduit on low slope roof systems.

Sizes & Packaging Information

SKU	Diameter Size (I.D.)	Package Qty.	Dimensional Weight Lbs. (Kg)
P-12100	1 3/4 (44.5) mm	5	14.77 (6.70)

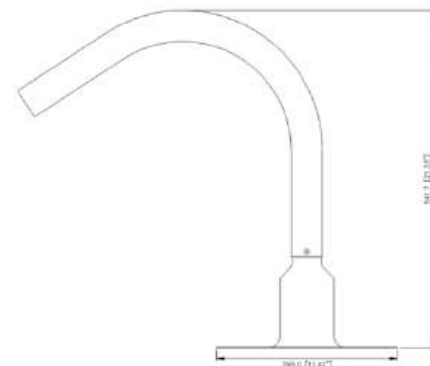

Please note that PLATINUM products may be periodically updated & are subject to change without prior notice. For additional information, contact PLATINUM ROOFING PRODUCTS at info@platinumroofingproducts.com



Electrical Flashings

4 - Nipple Flashing

- Seamless Spun Aluminum base measures 6" high and 14" in diameter
- Total height with EPDM Rubber boot is 9", providing a secure and reliable installation
- EPDM Rubber boot top features a double groove for a secure fit over the seamless Spun Aluminum base
- Includes 4 MJ clamps to secure and seal openings around wiring as needed
- Ideal for multiple wiring applications on low-slope roofs
- The kit includes the spun Aluminum base, 4-nipple EPDM rubber boot (SKU: P-4RB) and 4 MJ clamps in multiple sizes



Sizes & Packaging Information

SKU	Size (in.)	Package Qty.	Dimensional Weight Lbs. (Kg)
P-EF4N	14	5	2.60 (1.18)

Application

Electrical flashing in the roofing industry is crucial for creating a weather-tight seal around electrical conduits and service entries. Made from durable EPDM Rubber and Spun Aluminum it prevents water infiltration, safeguarding electrical systems and maintaining roof integrity. Proper installation minimizes leak risks and ensures compliance with building codes, enhancing the longevity of the roofing system. Ideal for multiple wiring applications on low slope roofs.

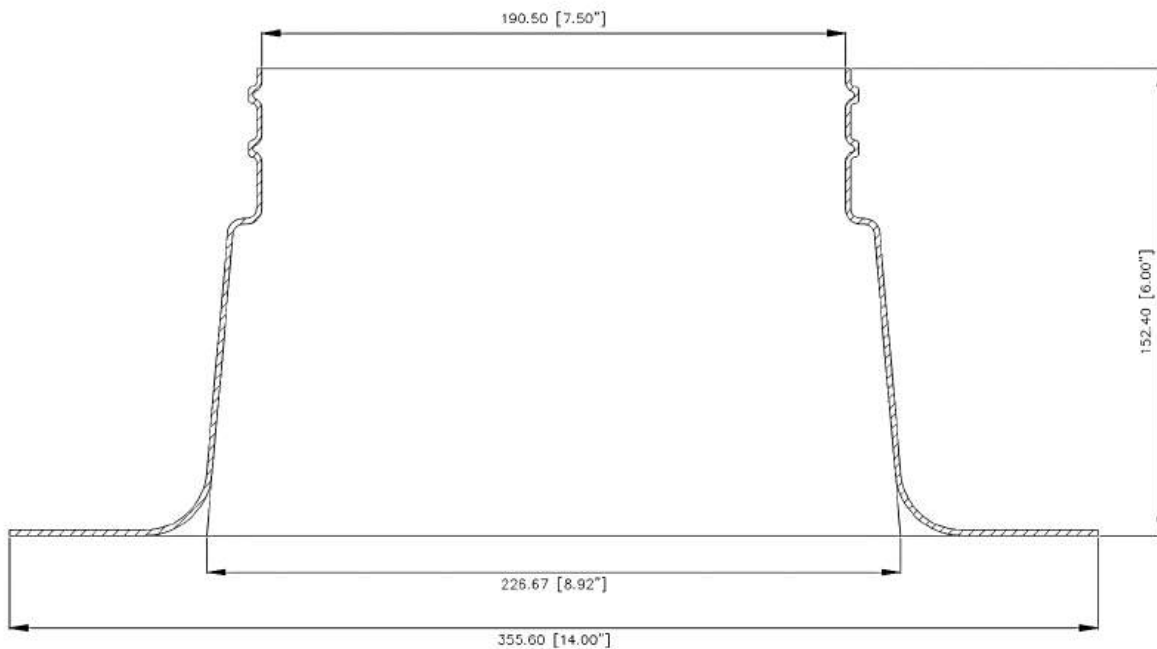

i To see more details about EPDM Rubber boot component, please see page 22 of this catalogue.



Roof Anchor Flashings

P-RAF500 - Roof Anchor Flashing

- 1"-5" roof anchor flashing features an EPDM top and a Spun Aluminum base, including 5 MJ clamps for securing roof anchors ranging from 1" to 5" in diameter
- Seamless base made of high-grade Aluminum with a material thickness of 1.8 mm, measuring 8" in height, plus an EPDM Rubber boot cap with a 16" diameter base
- Designed for use with all roofing systems except inverted roofs, making it ideal for both retrofit and new construction applications
- Provides a watertight seal for varying sizes of roof anchors (1", 2", 3", 4", or 5" diameters)
- Custom Spun ridge on the Aluminum base ensures a tight overlapping seal with the EPDM Rubber boot
- EPDM/PP Rubber boot is designed to withstand temperature ranges of -50°C and offers a long life expectancy
- The kit includes the Spun Aluminum base, EPDM Rubber boot (SKU: P-5RB) and 5 MJ clamps in multiple sizes

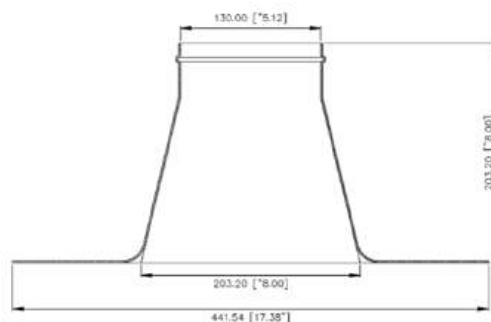

P-RAPF500-W - Roof Anchor Plate Flashing

- 1"-5" roof anchor plate flashing for inverted roofs features an EPDM top and a wide oversized Spun Aluminum base to accommodate a 12" Steel base plate and bolts up to 3.5" high on inverted roof systems
- Includes 5 MJ clamps, covering nominal anchor diameters from 1" to 5"
- The Aluminum base is 9" in height (plus a 4.5" boot height) and 24" wide with a 3" flange
- Ideal for both retrofit and new construction applications, providing a watertight seal for varying sizes of roof anchors (1", 2", 3", 4", or 5" diameters)
- Custom Spun ridge on the Aluminum base ensures a tight overlapping seal with the EPDM Rubber boot over the Spun Aluminum base
- EPDM/PP Rubber boot is designed to withstand temperature ranges of -50°C and offers a long life expectancy
- The kit includes the Spun Aluminum base, EPDM Rubber boot (SKU: P-5RB) and 5 MJ clamps in multiple sizes

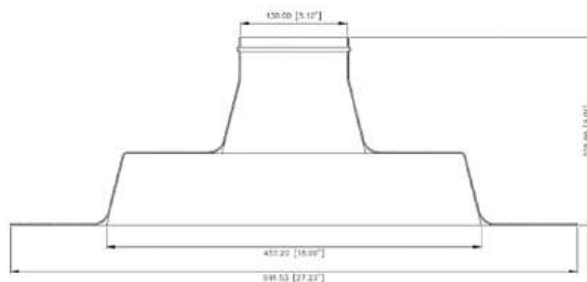

Sizes & Packaging Information

SKU	Package Qty.	Dimensional Weight Lbs. (Kg)
P-RAF500	5	2.00 (0.91)
P-RAPF500	5	4.89 (2.22)

Application

Designed for roof anchors on inverted roofs. Ideal for either retrofit or new construction applications providing a watertight seal with varying sizes of roof anchors from 1", 2", 3" 4" or 5" diameters.

i To see more details about EPDM Rubber boot component, please see page 22 of this catalogue.

Please note that PLATINUM products may be periodically updated & are subject to change without prior notice. For additional information, contact PLATINUM ROOFING PRODUCTS at: info@platinumroofingproducts.com



EPDM Rubber Boots

4 - Nipple EPDM Rubber Boot

- Designed for 4 separate wiring locations, each featuring its own variable diameter cut-out
- EPDM material provide excellent flex fatigue resistance and Ozone resistance
- Includes 2 large diameter 2 1/2" openings and 2 smaller 1 1/2" openings
- Compatible with spun Aluminum electrical flashing (SKU: P-EF4N)



EPDM Rubber Boot

- Can withstand vibrations, pipe movement caused by expansion and contraction, and movements due to snow loads
- EPDM rubber composition provides superior resistance to ozone and ultraviolet damage
- Compatible with spun Aluminum roof anchor flashing (SKU: P-RAF500) and roof anchor plate flashing (SKU: P-RAPF500-W)



Sizes & Packaging Information

SKU	Package Qty.	Dimensional Weight Lbs. (Kg)
P-4RB	5	0.53 (0.24)
P-5RB	5	0.25 (0.11)

Spun Aluminum Tall Cones

Specifications

- Constructed from Spun Aluminum cones without welded seams for enhanced durability
- Available in sizes:
 - 1 1/2", 2", 3", 4", 5", and 6" with a material thickness of 0.06 mm
 - 7", 8", 9", 10", 11" and 12" with a material thickness of 0.08 mm
 - 14", 16", 18", 20", 22", and 24" with a robust material thickness of 2 mm
- Made from premium grade 1060 Aluminum, ensuring higher quality and heavier gauge than most other brands
- Simple and easy to install, facilitating quick setup



Application

Spun Aluminum tall cones are used to provide a durable and watertight seal around roof penetrations, such as vent pipes or stacks. They offer protection from weather elements and are designed to accommodate taller cone collars, ensuring long-lasting performance and preventing leaks.

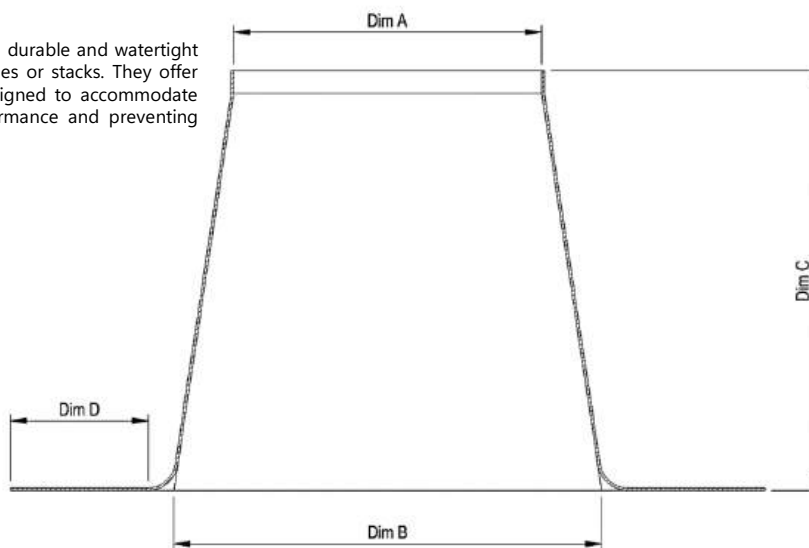

Sizes & Packaging Information

SKU	Size (in.)	Dim. "A" Top I.D. (in.)	Dim. "B" Bottom I.D. (in.)	Dim. "C" Total Height (in.)	Dim. "D" Flange Size (in.)	Package Qty.	Dimensional Weight Lbs. (Kg)
P-80331	1 1/2	1 1/2	3 1/2	8	3 3/8	25	0.88 (0.40)
P-80332	2	2	4	8	4	25	1.14 (0.52)
P-80333	3	3	7	12	4	25	1.32 (0.60)
P-80334	4	4	7 3/4	12 3/8	4 5/8	25	2.06 (0.93)
P-80335	5	5	8 3/8	12 1/4	4 3/8	25	2.22 (1.01)
P-80310	6	6	9 1/2	12 1/4	4 1/4	25	2.21 (1.00)
P-80337W	7	7	10 1/2	12	4	10	2.60 (1.18)
P-80338	8	8	11 3/4	12 5/8	4	10	2.84 (1.29)
P-80339W	9	9	12 1/2	12 1/4	4	10	2.85 (1.29)
P-80340	10	10	13 1/2	12	3 3/4	10	3.21 (1.46)
P-80351	11	11	14 1/2	12	4	10	3.40 (1.54)
P-80341	12	12	15 1/2	11	4 1/8	10	3.63 (1.65)
P-13214	14 1/4	14 1/4	18	11	4	5	4.40 (2.00)
P-13216	16 1/4	16 1/4	19 3/4	11	4	5	4.8 (2.18)
P-13218	18 1/4	18 1/4	22	11	4	5	5.33 (2.42)
P-13220	20 1/4	20 1/4	28	12 7/8	4 3/4	5	6.30 (2.86)
P-13222	22	22	28	12 7/8	4 3/4	5	6.30 (2.86)
P-13224	24 1/4	24 1/4	28	11	4	5	6.08 (2.76)

Please note that PLATINUM products may be periodically updated & are subject to change without prior notice. For additional information, contact PLATINUM ROOFING PRODUCTS at: info@platinumroofingproducts.com



Vent Stacks Steel



Vent Stacks
SKU: P-80311-1
P-80311-18



Wide-Base Vent Stack
SKU: P-80311-1W

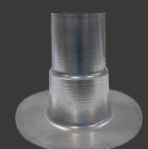

Oversize Vent Stack
SKU: P-VSB6
P-VSB7

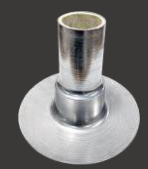

Insulated Vent Stack
SKU: P-INS-80311W

Vent Stack Caps



Vandal Proof Cap
SKU: P-80311-2/3



3" Vent Stack Cap
SKU: P-90154



4" Vent Stack Cap
SKU: P-90155



3" Vent Stack Cap (Compatible With Oversize Vent Stacks Only)
SKU: P-VSC300



3.75" Vent Stack Cap (Compatible With Oversize Vent Stacks Only)
SKU: P-VSC375



6" Vent Stack Cap (Compatible With Oversize Vent Stacks Only)
SKU: P-VSC6

Vent Stacks

Regular & Wide-Base Vent Stacks

- Premium gauge seamless Spun Aluminum construction with a 0.07" (1.8mm) material thickness
- Available in heights of 12.6" (320 mm) and 18" (457 mm) without the cap, featuring top opening interior dimensions of 4.88" (124 mm)
- All Platinum Aluminum products are Spun using soap as a lubricant and thoroughly washed, leaving no oil residue like other products
- Available with either a 3" or 4" cap or vandal proof cap, made of Spun Aluminum and securely attached to the vent stack with screws

Application

Vent stacks in roofing systems are used to provide proper ventilation for plumbing systems, allowing air to escape from soil stacks or sanitary pipes. They help maintain consistent air pressure and prevent sewer gases from entering the building.

Standards & Approvals

All Platinum vent stacks are QAI-certified to comply with **CSA-B272-93** standards.

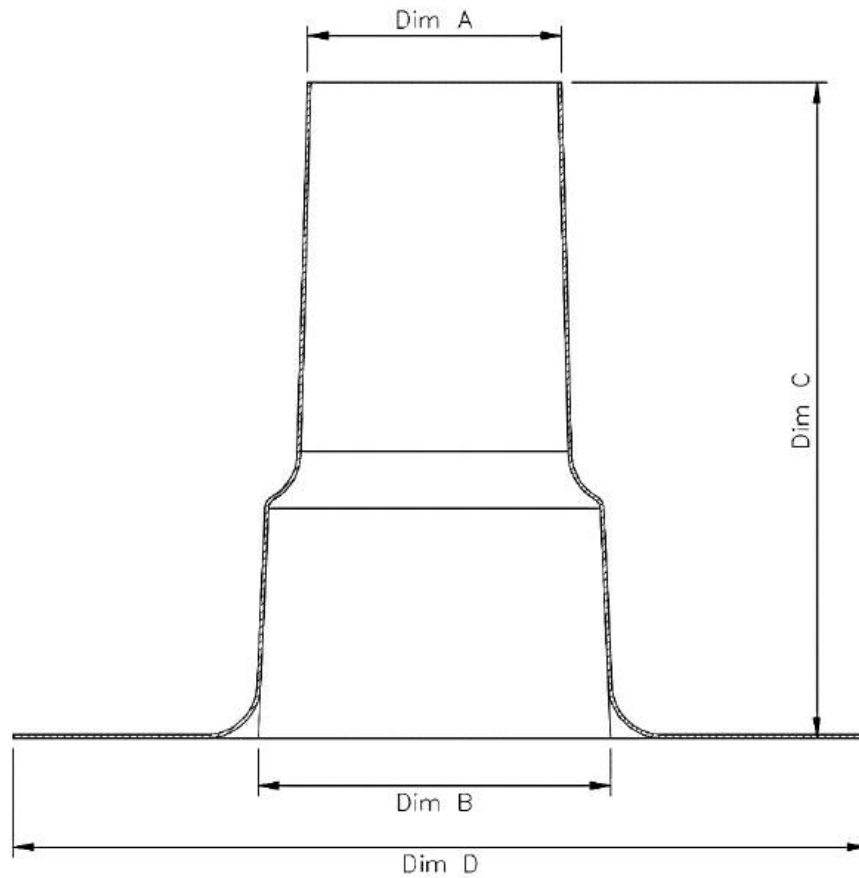

Sizes & Packaging Information

SKU	Dim. "A" Top I.D. (in.)	Dim. "B" Bottom I.D. (in.)	Dim. "C" Total Height (in.)	Dim. "D" Flange Size (in.)	Package Qty.	Dimensional Weight Lbs. (Kg)
P-80311-1	4 7/8	6 3/4	12 5/8	13 7/8	20	1.54 (0.70)
P-80311-1W	4 7/8	6 3/4	12 5/8	16 1/2	20	1.62 (0.73)
P-80311-18	4 7/8	6 3/4	18	15 7/8	10	1.88 (0.85)

i To see more details about vent stack caps, please see page 27 of this catalogue.





Vent Stacks

Oversize Vent Stacks

- Premium gauge seamless Spun Aluminum construction with a 0.07" (1.8mm) material thickness
- Available in heights of 12.63"(320mm) and 14.96"(380mm) without cap featuring top opening interior dimension of 6"(152mm) for VSB6 model and 7"(178mm) for VSB7 model
- Wide deck flange for enhanced adhesion
- Available 3" (76.2 mm) & 3 3/4" (95.25 mm) caps for VSB6 & 6" (152mm) cap for VSB7
- All Platinum Aluminum products are Spun using soap as a lubricant and thoroughly washed, leaving no oil residue like other products

Application

Vent stacks in roofing systems are used to provide proper ventilation for plumbing systems, allowing air to escape from soil stacks or sanitary pipes. They help maintain consistent air pressure and prevent sewer gases from entering the building.

Standards & Approvals

All Platinum vent stacks are QAI-certified to comply with **CSA-B272-93** standards.

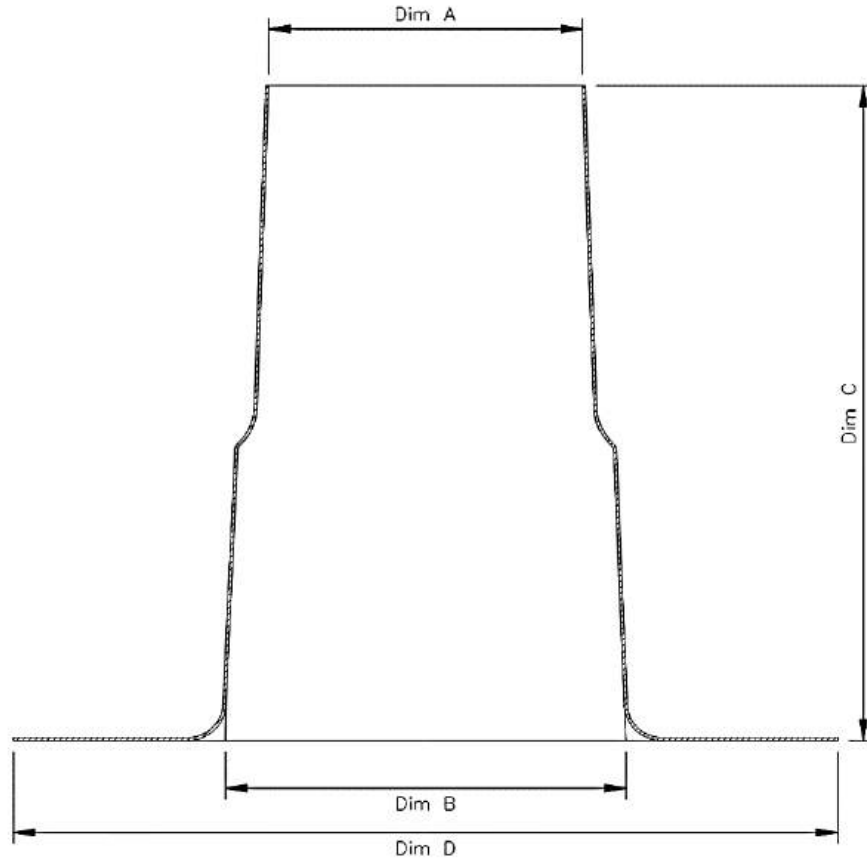

Sizes & Packaging Information

SKU	Dim. "A" Top I.D. (in.)	Dim. "B" Bottom I.D. (in.)	Dim. "C" Total Height (in.)	Dim. "D" Flange Size (in.)	Package Qty.	Dimensional Weight Lbs. (Kg)
P-VSB6	6	7 7/8	12 5/8	14 13/16	5	1.54 (0.70)
P-VSB7	7 1/8	9 1/8	14 13/16	18 7/8	5	2.92 (1.32)

To see more details about vent stack caps, please see page 28 of this catalogue.

Vent Stacks

Insulated Vent Stack

- Premium gauge seamless Spun Aluminum construction with a 0.07" (1.8mm) material thickness
- 12 5/8" (320mm) tall stack height without cap featuring top opening interior dimensions of 4.01" (102 mm) between foam walls
- Heat-molded injected Polyurethane foam with a uniform insulation thickness of 0.36" (9.2 mm) on all interior walls
- All Platinum Aluminum products are Spun using soap as a lubricant and thoroughly washed, leaving no oil residue like other product
- Available with either a 3" or 4" cap or vandal proof cap, made of Spun Aluminum and securely attached to the vent stack with screws

Application

Vent stacks in roofing systems are used to provide proper ventilation for plumbing systems, allowing air to escape from soil stacks or sanitary pipes. They help maintain consistent air pressure and prevent sewer gases from entering the building.

Standards & Approvals

All Platinum vent stacks are QAI-certified to comply with **CSA-B272-93** standards.

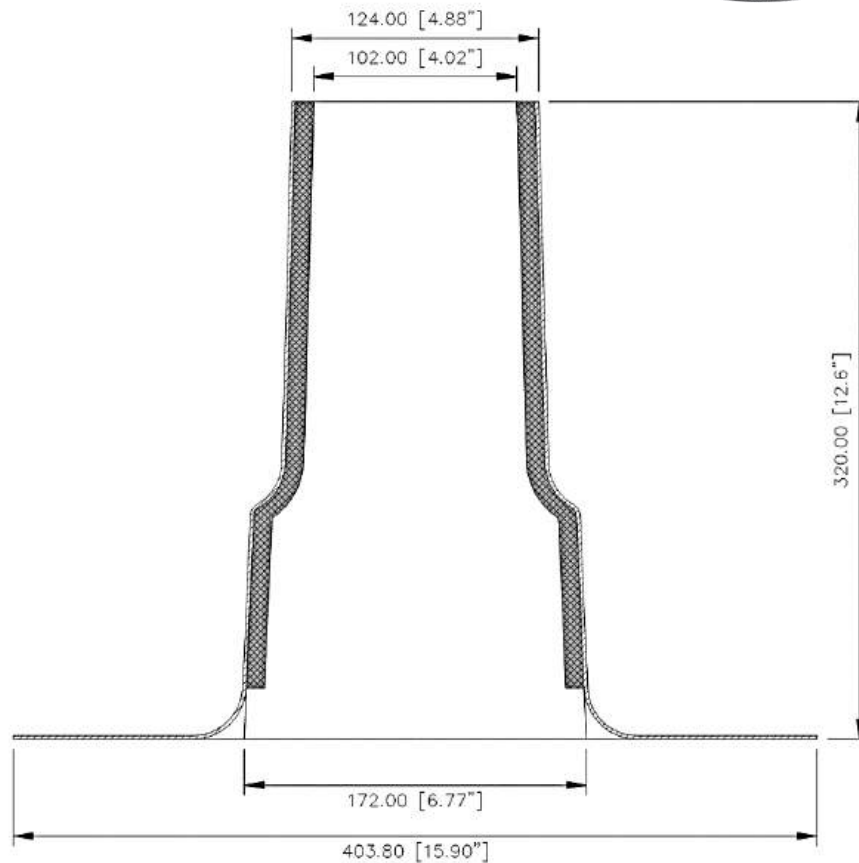

Sizes & Packaging Information

SKU	Package Qty.	Dimensional Weight Lbs. (Kg)
P-INS-80311W	10	2.22 (1.01)

i To see more details about vent stack caps, please see page 27 of this catalogue.





Vent Stack Accessories

Vent Stack Caps

- Caps are constructed from Spun Aluminum and securely attached to the vent stack with screws
- Made from heavier grade Aluminum for enhanced durability
- The vandal-proof cap prevents vandals from pouring rooftop gravel into vent stacks, which can lead to costly plumbing repairs, while round vent holes help deter birds from entering or nesting

Application

Compatible with both uninsulated vent stack bases (SKU:P-80311-1,P-80311-18,P-80311-1W) and insulated vent stack base (SKU: P-INS-80311W) for versatile installation.



Sizes & Packaging Information

SKU	Package Qty.	Dimensional Weight Lbs. (Kg)
P-90154	20	0.41 (0.19)
P-90155	20	0.42 (0.19)
P-80311-2/3	10	0.62 (0.28)

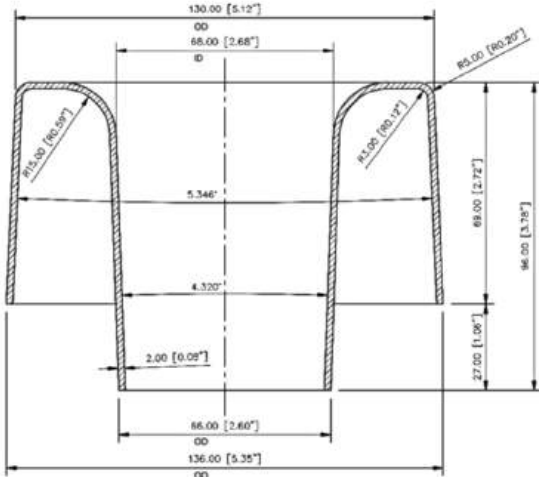

P-90154

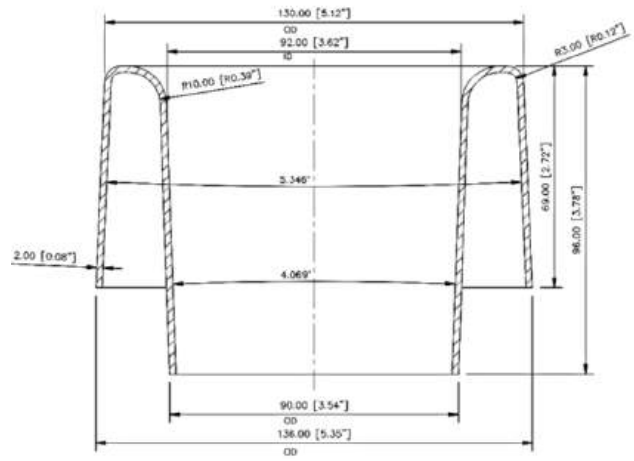

P-90155

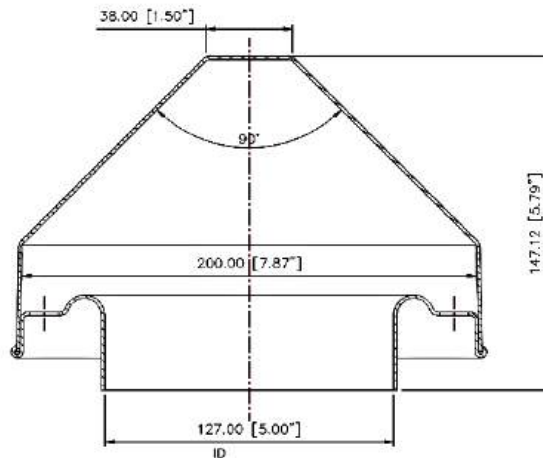

P-80311-2/3

Vent Stack Caps

Enlarge Vent Stack Caps

- Caps are constructed from Spun Aluminum and securely attached to the vent stack with screws
- Made from heavier grade Aluminum for enhanced durability

Application

P-VSC300 & P-VSC375 caps are Compatible with Enlarge vent stack base (SKU:P-VSB6) and P-VSC6 cap is compatible with enlarge vent stack base (SKU: P-VSB7) for versatile installation.



Sizes & Packaging Information

SKU	Package Qty.	Dimensional Weight Lbs. (Kg)
P-VSC300	10	0.53 (0.24)
P-VSC375	10	0.52 (0.24)
P-VSC6	5	0.66 (0.30)

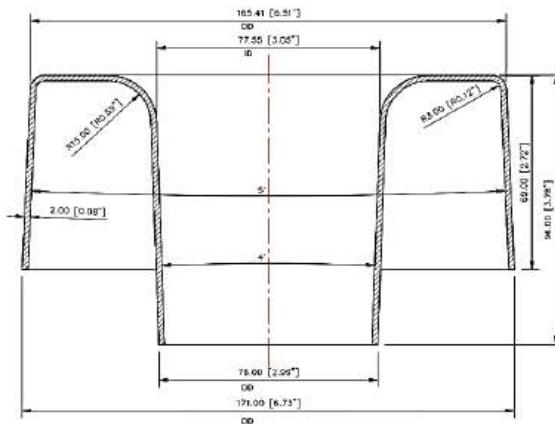

P-VSC300

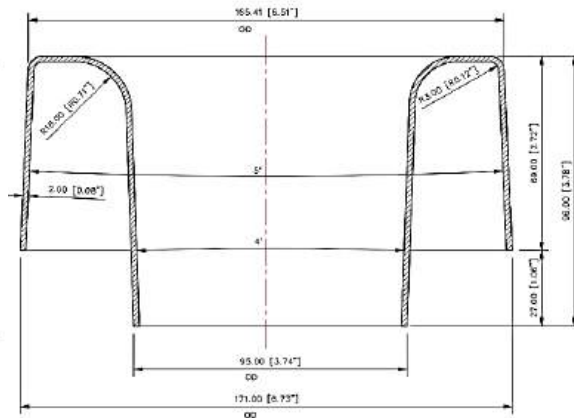

P-VSC375

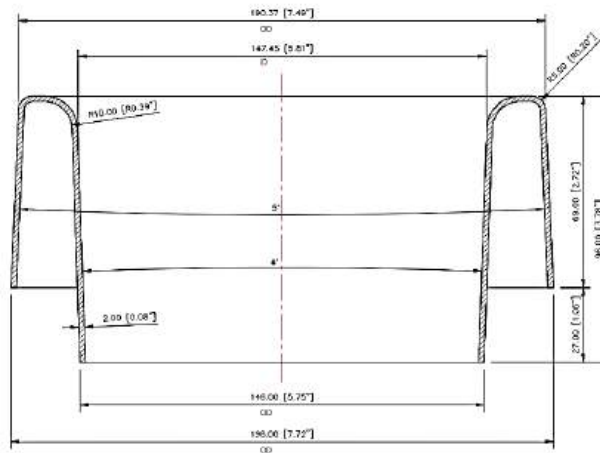

P-VSC6

Please note that PLATINUM products may be periodically updated & are subject to change without prior notice. For additional information, contact PLATINUM ROOFING PRODUCTS at: info@platinumroofingproducts.com



Spun Aluminum Breathers

Insulated One-Way Breather

- Two piece premium gauge Spun Aluminum with a 0.05" (1.5mm) material thickness
- The secured vandal-proof cap prevents rain or snow entry
- One-way roof vent with an internal flexible one-way diaphragm minimizing moisture and trapping air within the roofing system to extend the roof's lifespan
- Vented 7" wide cap with integral bug screen
- 12" tall vent height featuring a 15" wide deck flange
- 3/4" thickness Polyurethane foam insulated walls

Application

One-way breathers allow moisture and trapped air to escape from the roofing system while preventing water and debris from entering. This helps reduce condensation and pressure buildup, prolonging the roof's lifespan by preventing damage from moisture. Placement depends on the breather's venting capacity. For a 3.5" (89 mm) throat opening, it is recommended to install one breather for every 150 square feet (14 square meters) of roof area.

Sizes & Packaging Information

SKU	Package Qty.	Dimensional Weight Lbs. (Kg)
P-13008W	5	2.00 (0.91)

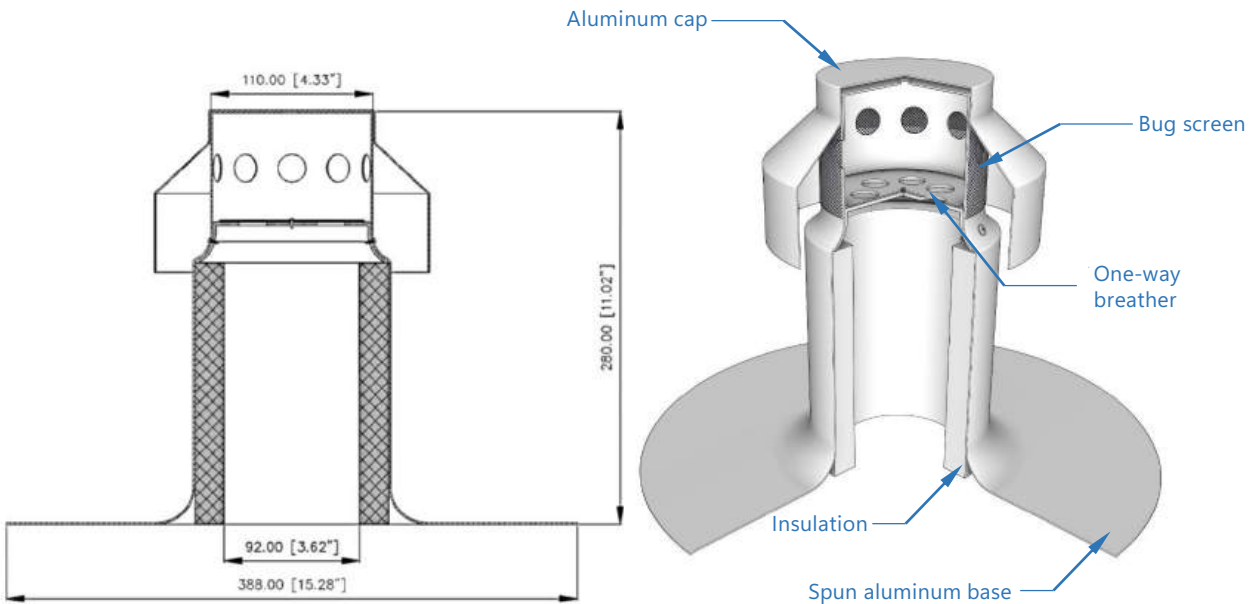



Two-Way Breathers

Specifications

- Two piece premium gauge Spun Aluminum with a 1/16" (1.8mm) material thickness
- Cap secured to ensure watertight two-way ventilation, standing 15" (381mm) high with a 4 1/2" (114mm) cap overlap
- Pre-drilled holes enable optimal venting and air pressure equalization

Application

Two-way breathers are used to equalize air pressure and manage moisture within the roofing system. It allows airflow in both directions, preventing the buildup of condensation and prolonging the roof's lifespan by reducing trapped air and moisture under the roofing membrane. Ideal for use in insulated or protected membrane systems, it helps maintain the integrity of the roof by promoting proper ventilation.



Sizes & Packaging Information

SKU	Package Qty.	Dimensional Weight Lbs. (Kg)
P-13009	5	4.30 (1.95)

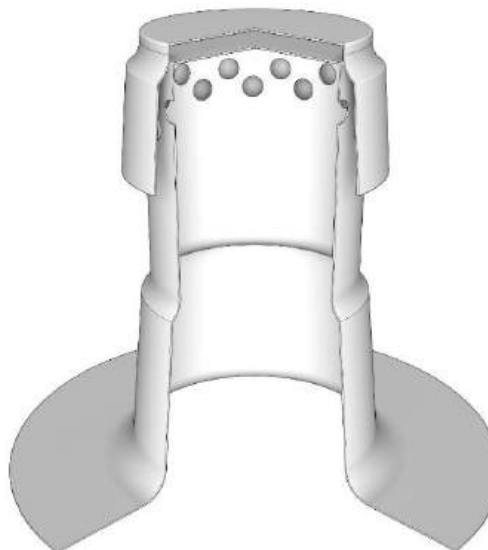
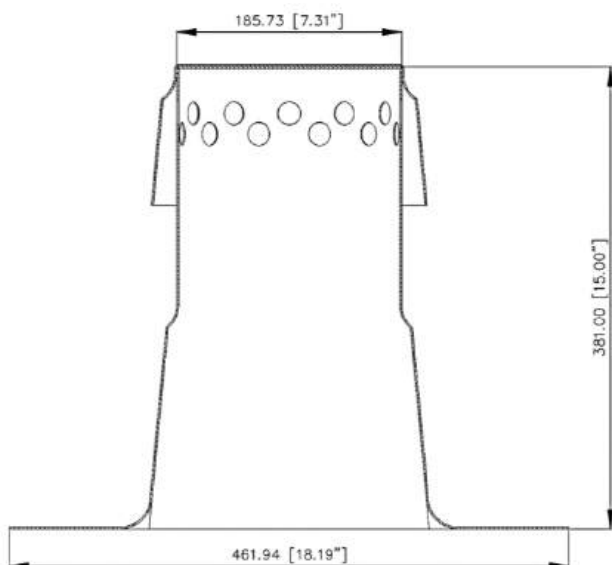

Please note that PLATINUM products may be periodically updated & are subject to change without prior notice. For additional information, contact PLATINUM ROOFING PRODUCTS at: info@platinumroofingproducts.com



SmartBlox Kit

SmartBlox Kit with 3.5" C clamp

- Robust heavy-duty gas line support featuring adjustable height and multiple head sizes for versatile applications
- Constructed from recycled modified Polypropylene, ensuring durability throughout the building's lifespan
- 10" x 10" base insulated with 1" thick closed-cell XPS foam for enhanced protection
- Engineered to support gas lines with diameters ranging from 1" to 6"
- Available 3 1/2" clamp size by default included in the kit
- Pipe clamp sizes offered in 2 1/2" and 6 1/2" size for various pipe diameters
- Mid-section support size offered in 4" for added stability
- Adjustable height from 4" to 12" to effectively center the top support bracket

Application

SmartBlox systems securely hold and elevate gas pipes above the roof surface, ensuring proper load distribution to prevent damage to roofing materials. It facilitates drainage by preventing water pooling and accommodates thermal expansion and contraction of pipes, reducing stress on both the pipes and the roofing system. Additionally, SmartBlox systems improve accessibility for maintenance and inspections, extending the lifespan of both the roofing and piping systems while ensuring compliance with building codes and standards.

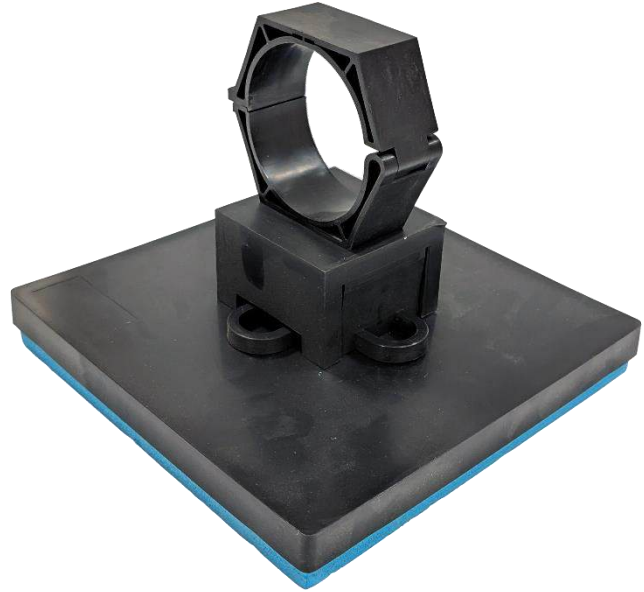

Sizes & Packaging Information

SKU	Package Qty.	Dimensional Weight Lbs. (Kg)
P-SBK-3.5	5	2.12 (0.96)

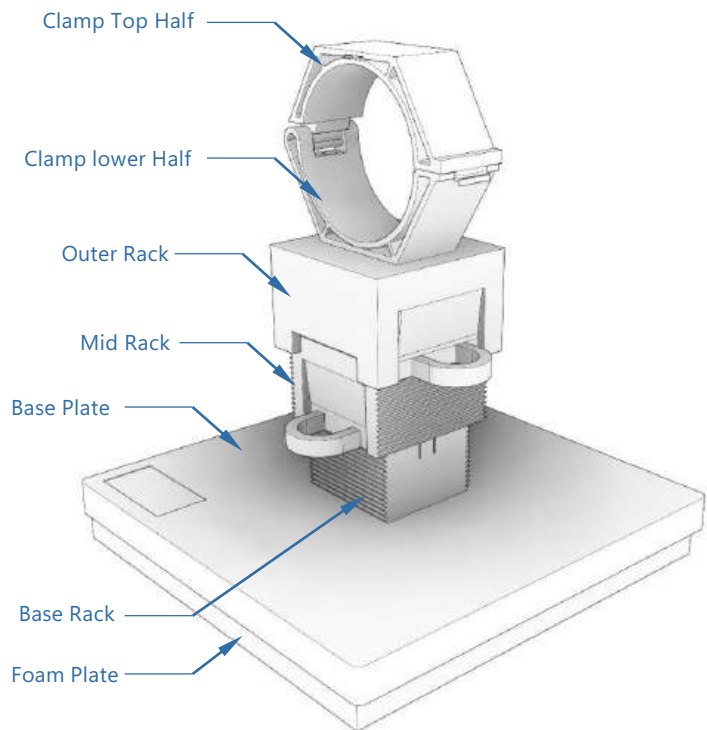
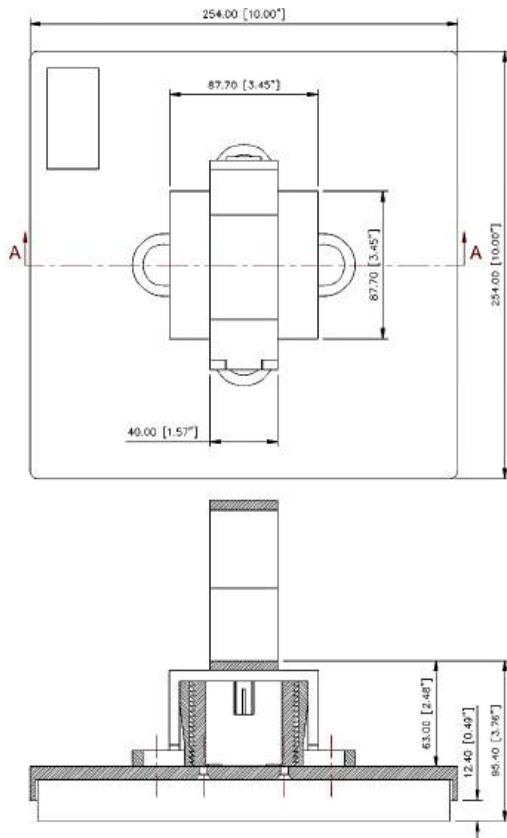

SmartBlox Kit | Add-Ons



Pipe Clamps

- Available in 2 1/2" and 6 1/2" sizes
- Constructed from recycled modified Polypropylene, ensuring durability throughout the building's lifespan
- Additional part to suit various pipe sizes



4" Mid-Section

- Constructed from recycled modified Polypropylene, ensuring durability throughout the building's lifespan
- Additional part to adjust the height of the SmartBlox unit



Sizes & Packaging Information

SKU	Package Qty.	Dimensional Weight Lbs. (Kg)
P-SBK-2.5	5	0.10 (0.04)
P-SBK-6.5	5	0.70 (0.32)
P-SBK-4	5	0.32 (0.15)

Please note that PLATINUM products may be periodically updated & are subject to change without prior notice. For additional information, contact PLATINUM ROOFING PRODUCTS at: info@platinumroofingproducts.com



SmartBase Kit

SmartBase

- Promotes positive drainage by allowing water to flow underneath the concrete pavers
- Constructed from recycled modified Polypropylene with pre-manufactured extruded polystyrene insulation on the underside to protect roofing membranes, reducing labor for contractors
- Easy installation with no tools required, making setup quick and efficient
- Four pedestals are needed to elevate one concrete paver
- Box quantity: 60 pedestals per box for convenient bulk use

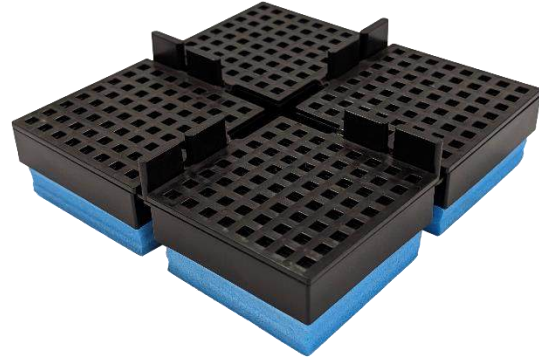

Application

Rugged pedestals designed to support concrete paving stones, ideal for creating walkways or patios in roofing applications.

Leveling Shims

- SmartBase Polypropylene Leveling Shims

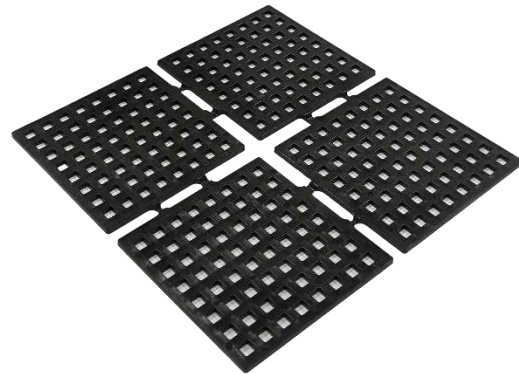

Application

Rugged pedestals designed to support concrete paving stones, ideal for creating walkways or patios in roofing applications.

Sizes & Packaging Information

SKU	Package Qty.	Dimensional Weight Lbs. (Kg)
P-Sbase	60	0.50 (0.23)
P-Shims	60	0.16 (0.07)



Marker Poles

Drain Dome Marker

- Highly visible 4' Fiberglass flexible pole for effective marking
- Cast Aluminum base securely attaches to the drain dome for stability
- Safety orange Fiberglass pole ensures maximum visibility, even in harsh conditions
- Enhances safety and visibility in areas with drifted snow
- Strong yet flexible pole resists breakage, providing long-lasting durability
- Speeds up drain maintenance in winter, making the process easier and more efficient

Application

Drain dome markers serve as essential indicators for the locations of roof drains, ensuring that they remain unobstructed and easily identifiable during inspections and maintenance. These markers are typically installed on or near drain domes clearly marking drain locations.

Gas Line Marker

- Highly visible 4' Fiberglass flexible pole for effective marking
- Cast Aluminum base securely attaches to the gas line support base for stability
- Safety yellow Fiberglass pole matches gas lines for easy identification
- Enhances safety and visibility, even in heavy snow or during snow removal
- Durable yet flexible pole resists breakage, ensuring long-lasting performance

Application

Gas line markers are crucial for identifying the location of gas lines that may run beneath or near roofing structures. These markers help ensure the safety of roofing professionals during installation, maintenance, or repair work by preventing accidental damage to gas lines. Clearly marked gas lines facilitate compliance with safety regulations and assist in planning for future roofing projects. By using color-coded markers that adhere to industry standards, workers can quickly recognize potential hazards, thereby minimizing the risk of gas leaks or explosions during roofing operations

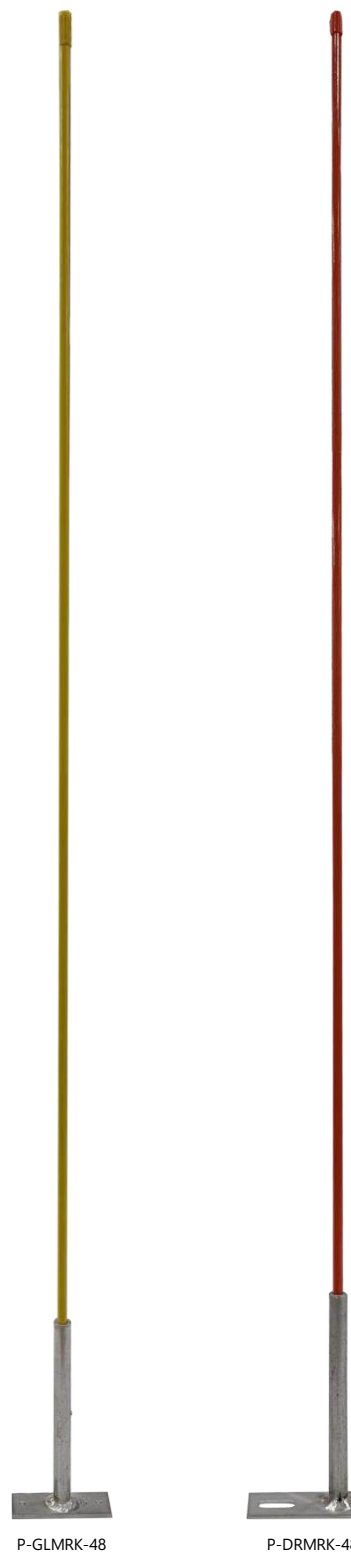

P-GLMRK-48

P-DRMRK-48

Sizes & Packaging Information

SKU	Package Qty.	Dimensional Weight Lbs. (Kg)
P-DRMRK-48	5	0.42 (0.19)
P-GLMRK-48	5	0.43 (0.20)

Please note that PLATINUM products may be periodically updated & are subject to change without prior notice. For additional information, contact PLATINUM ROOFING PRODUCTS at: info@platinumroofingproducts.com



Seal Screwdriver

- Specifically designed for installing Platinum seals with precision
- 10-teeth ratchet T-handle ensures smooth operation and control
- ¼" Stainless Steel construction with quick disconnect and locking bit system for fast, secure changes
- Extra-long 20" extension for improved reach in hard-to-access areas
- 36° bit holder allows for flexibility in tight spaces
- Square socket tip (#2 Robertson) for a secure fit and reliable performance
- Made with Silicon alloy Steel for durability and strength



P-DRNSLD-24

Termination Bar

- Extruded from lightweight premium 6063 Aluminum alloy with a smooth mill finish and no sharp edges for safety
- Features oval pre-drilled holes 5/16" x 3/8" (8 x 10 mm) for easy installation
- Standard hole spacing of 6 inches (150 mm) on center for consistent mounting
- Measures 10 feet in length and 1 inch in width, providing ample coverage
- Thickness of 1/8 inch for durability and strength
- Includes a 1/8" lip sealant edge for a secure and reliable seal

Application

The Platinum Termination Bar is precisely designed to ensure a smooth and professional finish when terminating roofing membranes at parapet walls and various other penetrations.



P-90354

Sizes & Packaging Information

SKU	Package Qty.	Dimensional Weight Lbs. (Kg)
P-90354	50	1.15 (0.52)



Bags on Roll

Skid Bags on Roll

- Clear with no prints, Transparent design for easy content visibility
- Provides protection against harmful UV rays, prolonging the lifespan of the bags and the contents
- 1.75 mm gauge, Durable thickness offering strong resistance against punctures and tearing
- 40 bags per roll, Convenient bulk packaging for extended use and easy handling
- Dimensions are 152" x 72" size, ensuring full coverage for large items or skids



P-SKIDBAG

Application

Specifically designed to fit and protect ISO skids efficiently. Made with UV protectant, strong and very versatile to cover large material.

Plastic Bags on Roll

- Clear with no prints for easy visibility of contents
- Perforated on roll, allowing for easy tearing and convenient handling of individual sheets
- 75 bags per roll for long-lasting use and added convenience
- 3.8mm thickness provides durable protection and extra strength
- 48" x 60" size, ideal for covering or wrapping medium-sized items
- High clarity polyethylene film offers excellent visibility and a professional finish
- Designed to handle and remove all types of garbage efficiently



P-CBAGS

Application

Very strong (3.8mm in thickness) poly bags are designed to remove and handle any type of garbage.

Sizes & Packaging Information

SKU	Package Qty.	Size (in.)
P-SKIDBAG	40	152 x 72
P-CBAGS	75	48 x 60

Please note that PLATINUM products may be periodically updated & are subject to change without prior notice. For additional information, contact PLATINUM ROOFING PRODUCTS at info@platinumroofingproducts.com.



Detergents

BLU.GRIT Cleaner

- Fast-acting and effective cleaner with pumice, designed to tackle tough grease, dirt, and oil while remaining gentle on your hands
- Enriched with Aloe and Vitamin E, and fortified with Jojoba oil to nourish and protect your skin
- Delivers a fresh, pure citrus scent, free from artificial fragrances and petroleum solvents
- Available in a 4-liter bottle with a pump for easy dispensing, and a 500ml bottle with a convenient push-pull cap for portability



P-BLU-GRIT-4

P-BLU-GRIT-500ml

Tar & Asphalt Remover

- Powered by natural Citrus cleaning agents for superior tar and asphalt removal
- Petroleum-free formula ensures safe use on a variety of surfaces
- Non-toxic composition for the safety of both users and the environment
- Biodegradable and eco-friendly, providing an effective and sustainable cleaning solution

Application

Effectively dissolves and removes Tar and Asphalt from Concrete, Stucco, Stainless Steel, Chrome, Aluminum, Grease, and metal equipment.



P-TAR&ASPHALT-REMOVER 4L

P-TAR&ASPHALT-REMOVER 1L

Sizes & Packaging Information

SKU	Package Qty.	Dimensional Weight Lbs. (Kg)
P-90354P-BLU-GRIT-4	4	8.80 (3.99)
P-BLU-GRIT-500ml	16	1.10 (0.50)
P-TAR&ASPHALT-REMOVER 1L	12	2.20 (1.00)
P-TAR&ASPHALT-REMOVER 4L	4	8.80 (3.99)



FIREGUARD Retardant Coating Spray

- Effectively slows the spread of flames
- Visible under UV light once fully applied
- Provides coverage of up to 75 sq. ft. per liter
- Colorless, odorless, and non-flammable
- Meets & exceeds all required standards, including ASTM E-84, CAN2-4.2-M77, NFPA 701, NFPA 703, and FAA
- Available in 1-liter spray bottles



P-PFG1000

QUICKSTOP Polymer Absorbant

- Made from 100% recycled material, this biodegradable product is environmentally friendly and naturally breaks down, minimizing its impact on the environment
- Non-flammable, it reduces fire hazards, ensuring safer use across various applications
- Absorbs water and turns it into a gel, making it highly effective for controlling spills and managing moisture
- Works effectively on various liquids, offering versatile solutions for different needs
- Highly absorbent, capable of soaking up to 200 times its weight in water, making it ideal for large spills
- Cleanup is easy with a shovel, simplifying disposal and saving time
- When sprinkled on damp Modified Bitumen, it acts like a sponge, absorbing moisture from the granules
- Suitable for use with all types of roofing membranes, providing flexibility for diverse projects
- Available in 700g bottles, and 6kg and 11kg pails to accommodate projects of various sizes



P-PQS-11

P-PQS-6

P-PQS-700g

Application

Polymer absorbents are utilized in the roofing industry primarily for quick access to identify a repair and complete the necessary repair immediately. This product is not for stopping leaks. Remove after completing the repair and dispose of properly.

Sizes & Packaging Information

SKU	Package Qty.	Dimensional Weight Lbs. (Kg)
P-PFG1000	12	2.20 (1.00)
P-PQS-11	64	24.25 (11.00)
P-PQS-6	128	13.22 (6.00)
P-PQS-700g	120	1.54 (0.70)

Please note that PLATINUM products may be periodically updated & are subject to change without prior notice. For additional information, contact PLATINUM ROOFING PRODUCTS at: info@platinumroofingproducts.com

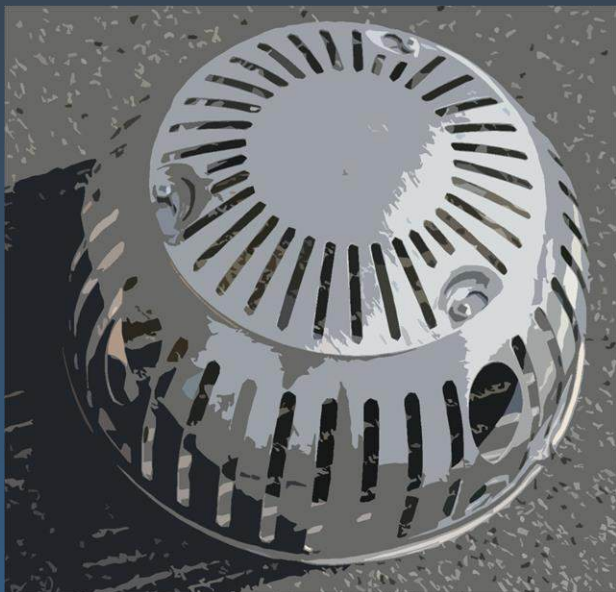

PLATINUM
ROOFING PRODUCTS INC.

Excellence in Roofing,
Service Beyond Compare...

For additional information, contact **PLATINUM ROOFING PRODUCTS**

1-800-538-7767

info@platinumroofingproducts.com

www.platinumroofingproducts.com